Trademarks

Autel®, MaxiSys®, MaxiDAS®, MaxiScan®, MaxiTPMS®, MaxiRecorder®, and MaxiCheck® are trademarks of Autel Intelligent Technology Corp., Ltd., registered in China, the United States and other countries. All other marks are trademarks or registered trademarks of their respective holders.

Copyright Information

No part of this manual may be reproduced, stored in a retrieval system or transmitted, in any form or by any means, electronic, mechanical, photocopying, recording, or otherwise without the prior written permission of Autel.

Disclaimer of Warranties and Limitation of Liabilities

All information, specifications and illustrations in this manual are based on the latest information available at the time of printing.

Autel reserves the right to make changes at any time without notice. While information of this manual has been carefully checked for accuracy, no guarantee is given for the completeness and correctness of the contents, including but not limited to the product specifications, functions, and illustrations.

Autel will not be liable for any direct, special, incidental, indirect damages or any economic consequential damages (including lost profits).

IMPORTANT

Before operating or maintaining this unit, please read this manual carefully, paying extra attention to the safety warnings and precautions.

For Services and Support:



pro.autel.com

www.autel.com



1-855-288-3587/1-855-AUTELUS (North America)

0086-755-86147779 (China)



support@autel.com

For details, please refer to the *Service Procedures* in this manual.

Safety Information

For your own safety and the safety of others, and to prevent damage to the device and vehicles upon which it is used, it is important that the safety instructions presented throughout this manual be read and understood by all persons operating or coming into contact with the device.

There are various procedures, techniques, tools, and parts for servicing vehicles, as well as in the skill of the person doing the work. Because of the vast number of test applications and variations in the products that can be tested with this equipment, we cannot possibly anticipate or provide advice or safety messages to cover every circumstance. It is the automotive technician's responsibility to be knowledgeable of the system being tested. It is crucial to use proper service methods and test procedures. It is essential to perform tests in an appropriate and acceptable manner that does not endanger your safety, the safety of others in the work area, the device being used, or the vehicle being tested.

Before using the device, always refer to and follow the safety messages and applicable test procedures provided by the manufacturer of the vehicle or equipment being tested. Use the device only as described in this manual. Read, understand, and follow all safety messages and instructions in this manual.

Safety Messages

Safety messages are provided to help prevent personal injury and equipment damage. All safety messages are introduced by a signal word indicating the hazard level.

DANGER

Indicates an imminently hazardous situation which, if not avoided, will result in death or serious injury to the operator or to bystanders.

WARNING

Indicates a potentially hazardous situation which, if not avoided, could result in death or serious injury to the operator or to bystanders.

Safety Instructions

The safety messages herein cover situations Autel is aware of. Autel cannot know, evaluate or advise you in regards of all possible hazards. You must be certain that any condition or service procedure encountered does not jeopardize your personal safety.

 **DANGER**

When an engine is operating, keep the service area **WELL VENTILATED** or attach a building exhaust removal system to the engine exhaust system. Engines produce carbon monoxide, an odorless, poisonous gas that causes slower reaction time and can lead to serious personal injury or loss of life.

 It is not advised to use headphones at a high volume

Listening at high volumes for long periods of time may result in loss of hearing.

Safety Warnings

- Always perform automotive testing in a safe environment.
- Wear safety eye protection that meets ANSI standards.
- Keep clothing, hair, hands, tools, test equipment, etc., away from all moving or hot engine parts.
- Operate the vehicle in a well-ventilated work area.
- Put the transmission in PARK (for automatic transmission) or NEUTRAL (for manual transmission) and make sure the parking brake is engaged.
- Put blocks in front of the drive wheels and never leave the vehicle unattended while testing.
- Be extra cautious when working around the ignition coil, distributor cap, ignition wires and spark plugs. These components create hazardous voltages when the engine is running.
- Keep a fire extinguisher suitable for gasoline, chemical, and electrical fires nearby.
- Do not connect or disconnect any test equipment while the ignition is on or the engine is running.
- Keep the test equipment dry, clean, and free from oil, water, and grease. Use a mild detergent on a clean cloth to clean the outside of the equipment as necessary.
- Do not drive the vehicle and operate the test equipment at the same time. Any distraction may cause an accident.
- Refer to the service manual for the vehicle being serviced and adhere to all diagnostic procedures and precautions. Failure to do so may result in personal injury or damage to the test equipment.

- To avoid damaging the test equipment or generating false data, make sure the vehicle battery is fully charged and the connection to the vehicle DLC is clean and secure.
- Do not place the test equipment on the distributor of the vehicle. Strong electromagnetic interference can damage the equipment.

CONTENTS

1. USING THIS MANUAL	11
CONVENTIONS	11
<i>Bold Text</i>	11
<i>Notes and Important Messages</i>	11
<i>Hyperlink</i>	11
<i>Illustrations</i>	11
<i>Procedures</i>	12
2. GENERAL INTRODUCTION	13
MAXISYS TABLET	13
<i>Function Description</i>	13
<i>Power Sources</i>	15
<i>Technical Specifications</i>	16
VCI — J2534 ECU PROGRAMMING DEVICE	18
<i>Function Description</i>	18
<i>Power Sources</i>	19
<i>Technical Specifications</i>	20
DOCKING STATION	20
<i>Functional Description</i>	20
<i>Technical Specifications</i>	21
ACCESSORIES KIT	21
<i>Main Cable</i>	21
<i>OBDI Adapters</i>	22
<i>Other Accessories</i>	22
3. GETTING STARTED	24
POWER UP	24
<i>Application Buttons</i>	25
<i>Locator and Navigation Buttons</i>	26
<i>System Status Icons</i>	28
POWER DOWN.....	28
<i>Reboot System</i>	28
4. DIAGNOSTICS	29

ESTABLISH VEHICLE COMMUNICATION	29
<i>Vehicle Connection</i>	29
<i>VCI Connection</i>	31
<i>No Communication Message</i>	32
GETTING STARTED	33
<i>Vehicle Menu Layout</i>	33
<i>Vehicle Identification</i>	35
<i>Diagnostics Screen Layout</i>	40
AUTO SCAN	42
CONTROL UNIT	46
<i>Screen Messages</i>	48
<i>Making Selections</i>	48
ECU INFORMATION	49
TROUBLE CODES	50
<i>Read Codes</i>	50
<i>Erase Codes</i>	51
LIVE DATA	51
ACTIVE TEST	59
SPECIAL FUNCTIONS	61
PROGRAMMING AND CODING	62
<i>Coding</i>	63
<i>Reprogramming</i>	65
<i>Re-flash Errors</i>	66
GENERIC OBDII OPERATIONS	66
<i>General Procedure</i>	66
<i>Function Descriptions</i>	68
DIAGNOSTICS REPORT	71
EXIT DIAGNOSTICS	76
5. INTELLIGENT DIAGNOSTICS	77
ACCESSING INTELLIGENT DIAGNOSTICS FUNCTION	77
<i>Auto Scan</i>	77
<i>Scan System Faults</i>	78
<i>Access via Intelligent Diagnostics Button</i>	79
<i>Access via Intelligent Diagnostics Icon</i>	79

INTELLIGENT DIAGNOSTICS OPERATION	81
<i>Vehicle System and Detected DTC(s)</i>	82
<i>Technical Service Bulletin (OEM Information)</i>	83
<i>DTC Analysis</i>	84
<i>Repair Assist</i>	84
<i>Repair Tips</i>	90
<i>Relevant Cases</i>	91
6. SERVICE	92
OIL RESET SERVICE	93
ELECTRIC PARKING BRAKE (EPB) SERVICE	93
<i>EPB Safety</i>	93
TIRE PRESSURE MONITORING SYSTEM (TPMS) SERVICE	94
BATTERY MANAGEMENT SYSTEM (BMS) SERVICE	94
DIESEL PARTICLE FILTER (DPF) SERVICE	94
IMMOBILIZER (IMMO) SERVICE	95
STEERING ANGLE SENSOR (SAS) SERVICE	96
7. ADAS	97
8. DATA MANAGER	98
VEHICLE HISTORY.....	99
<i>Test Records</i>	100
WORKSHOP INFORMATION	101
CUSTOMER	101
IMAGE	103
PDF FILES.....	104
REVIEW DATA	104
UNINSTALL APPS	105
DATA LOGGING.....	105
9. SETTINGS.....	106
UNIT.....	106
LANGUAGE	106
PRINTING SETTINGS.....	107
<i>Printing Setting</i>	107

<i>Printing Operations</i>	107
NOTIFICATION CENTER	108
AUTO UPDATE	108
ADAS SETTINGS	108
VEHICLE LIST	109
SYSTEM SETTINGS	109
ABOUT	109
10. BATTERY TEST	110
TEST PREPARATION	110
<i>Inspect the Battery</i>	110
<i>Connect the Battery Tester</i>	110
IN-VEHICLE TEST	112
<i>Battery Test</i>	113
<i>Starter Test</i>	114
<i>Generator Test</i>	116
OUT-VEHICLE TEST	117
<i>Test Procedure</i>	117
<i>Test Results</i>	118
11. VCI MANAGER	119
VCI CONNECTION VIA BLUETOOTH	119
BAS CONNECTION VIA BLUETOOTH	121
VCI UPDATE	122
BAS UPDATE	123
12. UPDATE	124
13. SUPPORT	126
PRODUCT REGISTRATION	126
SUPPORT SCREEN LAYOUT	126
MY ACCOUNT	127
<i>Personal Info</i>	127
<i>Update Info</i>	127
<i>Service Info</i>	128
TRAINING	128

DATA LOGGING.....	128
FAQ DATABASE	129
14. MAXVIEWER.....	130
15. MAXIVIDEO.....	132
ADDITIONAL ACCESSORIES	133
<i>MaxiVideo Camera</i>	133
<i>Imager Head Accessories</i>	134
<i>Accessory Assembly</i>	134
<i>Technical Specifications</i>	136
OPERATIONS.....	136
16. QUICK LINK	138
17. REMOTE DESKTOP	139
OPERATIONS.....	139
18. MAXISCOPE	141
SAFETY INFORMATION	141
GLOSSARY.....	143
MAXISCOPE MODULE.....	145
<i>Power Source</i>	146
<i>Technical Specifications</i>	147
SCREEN LAYOUT AND OPERATIONS	149
<i>Top Toolbar</i>	150
<i>Function Buttons</i>	152
<i>Measurement Grid</i>	153
<i>Measurement Rulers</i>	154
<i>Function Buttons</i>	155
TROUBLESHOOTING	156
MAXISCOPE FIRMWARE UPDATE	157
19. USER FEEDBACK	158
20. MAINTENANCE AND SERVICE	159
MAINTENANCE INSTRUCTIONS	159
TROUBLESHOOTING CHECKLIST	159

ABOUT BATTERY USAGE	160
SERVICE PROCEDURES	161
<i>Technical Support</i>	161
<i>Repair Service</i>	162
<i>Other Services</i>	163
21. COMPLIANCE INFORMATION	164
22. WARRANTY	166

1. Using This Manual

This manual contains device usage instructions.

Some illustrations shown in this manual may contain modules and optional equipment that are not included in your system.

Conventions

The following conventions are used:

Bold Text

Bold text is used to highlight selectable items such as buttons and menu options.

Example:

- Tap **OK**.

Notes and Important Messages

Note

A NOTE provides helpful information such as additional explanations, tips, and comments.

Important

IMPORTANT indicates a situation that if not avoided may result in damage to the tablet or vehicle.

Hyperlink

Hyperlinks are available in electronic documents. Blue text indicates a selectable hyperlink, a website link or an email address link.

Illustrations

Illustrations used in this manual are samples, and the actual testing screen may vary for each vehicle being tested. Observe the menu titles and on-screen instructions to make correct option selection.

Procedures

An arrow icon indicates a procedure.

Example:

➤ **To use the camera**

1. Tap the **Camera** icon. The camera screen opens.
2. Focus the image to be captured in the viewfinder.
3. Tap the camera icon on the right side of the screen. The viewfinder now shows and auto-saves the captured photos.
4. Swipe the screen left to view the stored photos.
5. Tap the **Back** or **Home** button to exit the camera application.

2. General Introduction

The MaxiSys® Elite II Diagnostic Platform is the next generation of smart solution for specialized automotive diagnosis. Featuring the Samsung Exynos8895 8-core (4 × M2 2.3G + 4 × A53 1.7G) processor, a 9.7" HD display with a super sensitive capacitive touchscreen, combined with an optimized array of powerful applications, and the best possible coverage of OE-level diagnostics, the MaxiSys Elite II performs every job from comprehensive vehicle diagnostics and analysis to advanced ECU programming quickly and efficiently.

There are 3 main components to the MaxiSys Elite II system:

- MaxiSys Display Tablet — the central processor and monitor
- Vehicle Communication Interface (VCI) — the J2534 ECU Programming Device for accessing vehicle data with programming capabilities
- Docking Station — provides optimum visibility and convenient charging

This manual describes the construction and operation of the devices and how they work together to deliver diagnostic solutions.

MaxiSys Tablet

Function Description

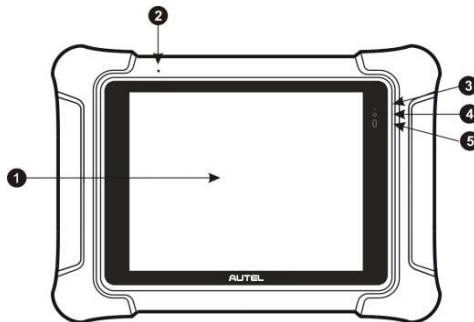

Figure 2-1 MaxiSys Tablet, Front View

1. 9.7" Retina display with capacitive touchscreen

2. Built-in Microphone
3. Battery Status LED — indicates battery level & charging or system status

The Battery Status LED indicates battery status:

- Charged — indicated by solid green light
- Charging — indicated by solid yellow light
- Low Battery — indicated by solid red light
- Standby — indicated by flashing blue light

4. Front Camera
5. Ambient Light Sensor — detects ambient brightness

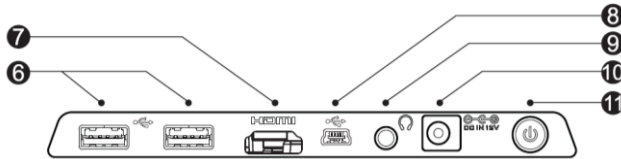

Figure 2-2 MaxiSys Tablet, Top View

6. USB Port — for Ethernet adapter and/or VCI connection
7. HDMI Port
8. Mini USB OTG Port
9. Headphone Jack
10. DC Power Supply Input Port
11. Lock/Power Button — long press to turn the device on/off, or short press to lock the screen

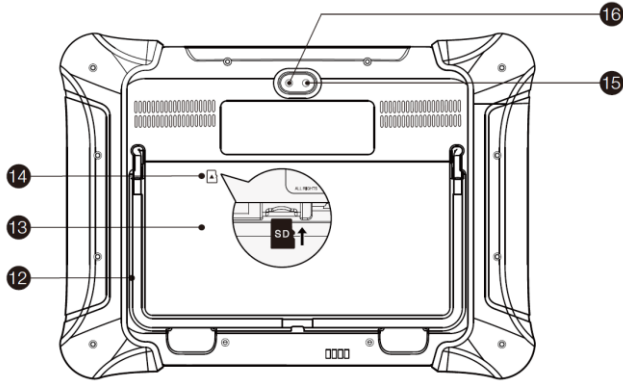

Figure 2-3 MaxiSys Tablet, Back View

12. Collapsible Stand — extends from the back to allow hands-free viewing of the display tablet
13. Removable Battery
14. Mini SD Card Slot
15. Camera Flash/Flashlight
16. Rear Camera

Power Sources

The MaxiSys Elite II can receive power from any of the following sources:

- Rechargeable Battery Pack
- AC/DC Power Supply — using external power adapter or docking station
- Vehicle Power

Rechargeable Battery Pack

The display tablet can be powered with its rechargeable battery pack, which if fully charged can provide sufficient power for about 5 hours of continuous operation.

AC/DC Power Supply

The display tablet can be powered from a wall socket using the AC/DC power adapter or the docking station. The AC/DC power supply also charges the battery pack.

Vehicle Power

The display tablet can be powered from the auxiliary power outlet adapter or other suitable power ports on the test vehicle through a direct cable connection. The vehicle power cable connects to the DC power supply port at the top of the display unit.

Technical Specifications

Table 2-1 Tablet Technical Specifications

Item	Description
Operating System	Android 7.0
Processor	Samsung Exynos8895 8-core (4 × M2 2.3 G + 4 × A53 1.7 G)
Memory	4 GB RAM & 128 GB Embedded Memory
Display	9.7" HD Display with 2048 × 1536 Resolution & Capacitive Touchscreen
Connectivity	<ul style="list-style-type: none">● Wi-Fi 802.11a/b/g/n/ac● Bluetooth Version 2.1 3 Mbs● RJ45 Ethernet Connection● USB 2.0● HDMI 1.4a● SD Card (Support up to 32 GB)
Camera	<ul style="list-style-type: none">● Rear: 16.0 Megapixel, Autofocus with Flashlight● Front: 5.0 Megapixel
Sensors	<ul style="list-style-type: none">● Ambient Light Sensor● G-sensor
Audio Input/Output	<ul style="list-style-type: none">● Microphone

Item	Description
	<ul style="list-style-type: none"> ● Dual Speakers ● 3-band 3.5 mm Stereo/Standard Headset Jack
Power and Battery	<ul style="list-style-type: none"> ● 3.7 V/15400 mAh Lithium-polymer Battery ● 12 V/3 A DC Power Supply
Input Voltage	12 V/3 A DC
Power Consumption	Max. 20 W
Operating Temp.	0 to 50°C (32 to 122°F)
Storage Temp.	-10 to 60°C (14 to 140°F)
Dimensions (WxHxD)	309 mm x 225 mm x 35 mm
Weight	1.65 kg
Protocols	ISO 9142-2, ISO 14230-2, ISO 15765-4, K/L-Line, Flashing Code, SAE-J1850 VPW, SAE-J1850 PWM, CAN ISO 11898, Highspeed, Middlespeed, Lowspeed and Singlewire CAN, GM UART, UART Echo Byte Protocol, Honda Diag-H Protocol, TP 2.0, TP 1.6, SAE J1939, SAE J1708, Fault-Tolerant CAN

VCI — J2534 ECU Programming Device

Function Description

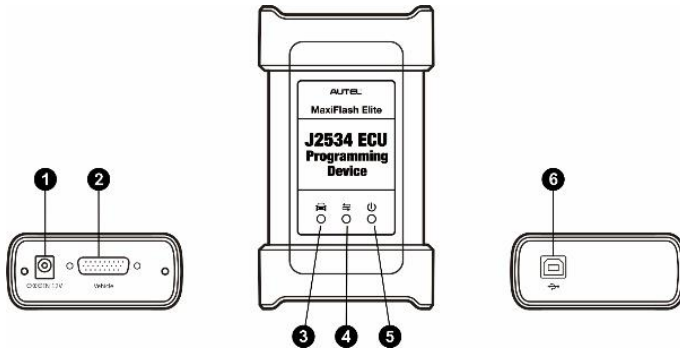

Figure 2-4 J2534 ECU Programming Device

1. DC Power Supply Input Port
2. Vehicle Data Connector (DB26-pin)
3. Vehicle LED
 - Flashes green when communicating with the vehicle's system

! IMPORTANT

DO NOT disconnect the reprogramming device while this status light is on. If the reprogramming procedure is interrupted while the vehicle's ECU is blank or only partially programmed, the module may be unrecoverable.

4. Tablet Connection Status LED
 - Lights solid green when connected with the display tablet via USB cable
 - Lights solid blue when connected with the display tablet via Bluetooth (BT) connection
5. Power LED
 - Lights solid green when powered on
 - Flashes red when system failure occurs
 - Lights amber when the VCI is powered on and performing the self-test
6. USB Port

J2534 Reprogramming Capability

The J2534 ECU Programming Device is a SAE J2534-1 & -2 compliant PassThru reprogramming interface device. Using the updated OEM software, it is capable of replacing the existing software/firmware in the Electronic Control Units (ECU), programming new ECUs, and fixing software-controlled drivability issues and emission issues.

Communication

The J2534 ECU Programming Device supports Bluetooth and USB communications. It can transmit vehicle data to the display tablet with or without a physical connection. The working range of the transmitter through Bluetooth communication is 210 feet (about 70 m). A signal lost due to moving out of range automatically restores itself when the display tablet unit is brought closer to the VCI unit.

Power Sources

The J2534 ECU Programming Device can receive power from both of the following sources:

- Vehicle Power
- AC/DC Power Supply

Vehicle Power

The J2534 ECU Programming Device operates on 12-volt vehicle power, which it receives through the vehicle data connection port. The device powers on whenever it is connected to an OBDII/EOBD compliant Data Link Connector (DLC). For non OBDII/EOBD compliant vehicles, the device can be powered from an auxiliary power outlet adapter or other suitable power ports on the test vehicle using the auxiliary power cable.

AC/DC Power Supply

The J2534 ECU Programming Device can be powered from a wall socket using the AC/DC power adapter.

Technical Specifications

Table 2-2 J2534 Programming Device Specifications

Item	Description
Communications	<ul style="list-style-type: none">● Bluetooth● USB 2.0
Wireless Frequency	Bluetooth V2.1+EDR, 2.4 GHz
Input Voltage Range	12 V DC to 24 V DC
Supply Current	<ul style="list-style-type: none">● 170 mA @ 12 V DC● 100 mA @ 24 V DC
Operating Temperature	0 to 50°C (32 to 122°F)
Storage Temperature	-10 to 60°C (14 to 140°F)
Dimensions (L x W x H)	149 mm (5.87") x 86 mm (3.38") x 35 mm (1.28")
Weight	0.29 kg (0.64 lb.)

Docking Station

Functional Description

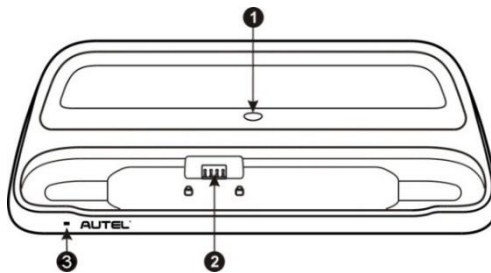

Figure 2-5 Docking Station

1. DC Power Port — connects to the AC/DC adapter for power supply
2. Charging Dock — holds the MaxiSys tablet while providing optimum visibility and

convenient charging

3. Status Indicator Light

The Indicator Light indicates the tablet status as described below:

- Green — battery power of the tablet is sufficient ($\geq 90\%$).
- Yellow — battery level is between 14 to 90%.
- Red — battery level is lower than 14%.

NOTE

Please make sure no small metal or other conductive parts contact the Charging Dock to avoid short circuit damage to the device.

Technical Specifications

Table 2-3 Docking Station Specifications

Item	Description
Input Voltage	12 V/3 A DC
Operating Temperature	-10 to 55°C (ambient)
Storage Temperature	-40 to 85°C (ambient)
Dimensions (L x W x H)	326.5 mm x 128.5 mm x 49 mm
Weight	0.79 kg (1.74 lb.)

Accessories Kit

Main Cable

The VCI device can be powered through the Main Cable when connected to an OBDII/EOBD compliant vehicle. The Main Cable connects the VCI device to the vehicle's Data Link Connector (DLC), through which the VCI device can transmit vehicle data to the display tablet.

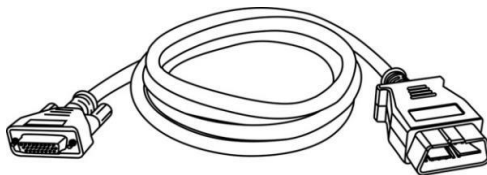

Figure 2-6 Main Cable — 1.5 m in length

OBDI Adapters

The OBDI-type adapters are for Non-OBDII vehicles. The adapter used depends on the type of vehicle being tested. The most common adapters are shown below (Adapters may be sold separately, please contact your distributor for details).



Benz-14



Chrysler-16



BMW-20



Nissan-14



Kia-20



Fiat-3



PSA-2



Mazda-17



Volkswagen/Audi-
2+2



Benz-38



Mitsubishi/Hyundai
-12+16

Other Accessories



USB Cable

Connects the tablet to the VCI unit.



AC/DC External Power Adapter

Connects the tablet to the external DC power port for power supply.



Auxiliary Power Outlet Adapter

Provides power to the tablet or the J2534 ECU Programming Device through the vehicle's auxiliary power outlet, as some non-OBDII vehicles cannot provide power via the DLC connection.



Clipper Cable

Provides power to the tablet or the J2534 ECU Programming Device by connecting to the vehicle's battery.

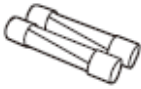

Spare Fuses

A safety device for the auxiliary power outlet adapter.

3. Getting Started

Make sure the tablet has sufficient power or is connected to the external power supply (see [Power Sources](#)).

Power Up

Long press the **Lock/Power** button on the top-right side of the tablet to switch the unit on. The system boots up and shows the lock screen with 3 entry options.

- MaxiSys Home — Swipe up on the MaxiSys Home icon to enter the MaxiSys Job Menu shown as below.
- Unlock — Swipe up on the Lock icon at the center to unlock the screen or enter the MaxiSys Job Menu when booting up.
- Camera — Swipe up on the Camera icon to launch the camera.

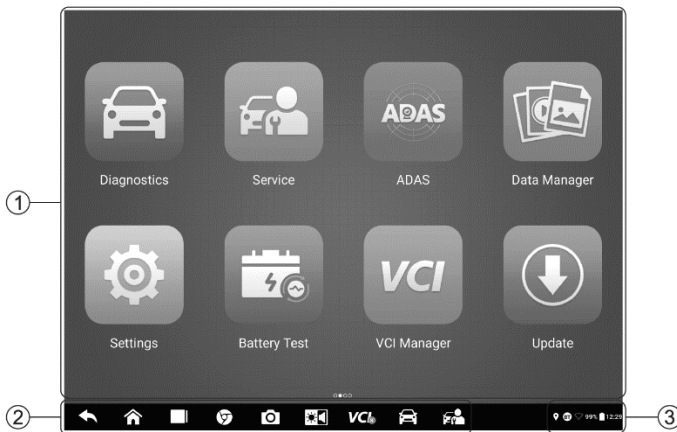

Figure 3-1 MaxiSys Job Menu

1. Application Buttons
2. Locator and Navigation Buttons
3. Status Icons

NOTE









It is recommended that you lock the screen when not in use to protect information in the system and conserve the power.







Almost all operations on the tablet are controlled through the touchscreen. The touchscreen navigation is menu driven, which allows you to quickly locate the test procedure or data that you need through a series of questions and options. Detailed descriptions of the menu structures can be found in the following chapters.

Application Buttons

The table below briefly describes each of the applications in the MaxiSys system.

Table 3-1 Application Buttons



Name	Button	Description
Diagnostics		Accesses the unit's diagnostics functions. See Diagnostics .
Service		Accesses special functions menu. See Service .
ADAS		Accesses ADAS systems menu. See ADAS .
Data Manager		Accesses the saved repair shop, customer and vehicle data including detailed vehicle diagnostics and test records. See Data Manager .
Settings		Accesses the system settings menu and general tablet menu. See Settings .
Battery Test		Accesses the Battery Test menu with in-vehicle test and out-vehicle test functions. See Battery Test .
VCI Manager		Accesses VCI connection menu. See VCI Manager .
Update		Accesses system software update menu. See Update .









Name	Button	Description
Support		Synchronizes Autel's online service database with the MaxiSys tablet. See Support .
MaxiViewer		Provides a quick search for supported functions and/or vehicles. See MaxiViewer .
MaxiVideo		Configures the unit to operate as a video scope device by connecting to an imager head cable for close vehicle inspections. See MaxiVideo .
Quick Link		Provides associated website bookmarks to allow quick access to product update, service, support, and other information. See Quick Link .
Remote Desktop		Configures your unit to receive remote support using the TeamViewer application. See Remote Desktop .
MaxiScope		Configures the MaxiSys Diagnostic Device to operate as an automotive oscilloscope when work in combination with the MaxiScope module. See MaxiScope .
User Feedback		Allows you to submit questions related to this product. See User Feedback .

Locator and Navigation Buttons

Operations of the navigation buttons at the bottom of the screen are described in the table below:

Table 3-2 Locator and Navigation Buttons

Name	Button	Description
Locator		Indicates the location of the current screen. Swipe left or right to view the previous or next screen.
Back		Returns to the previous screen.

Name	Button	Description
Android Home		Returns to the MaxiSys Job Menu.
Recent Apps		Displays a list of applications that are currently running. Tap an app icon to launch. Remove an app by swiping it to the right.
Browser		Launches the Google Chrome browser.
Camera		Tap to launch camera. Press and hold the icon to capture a screenshot of the display screen. Saved files are stored in the Data Manager application for later review. See Data Manager .
Display & Sound		Adjusts the brightness of the screen and the volume of the audio output.
VCI		Opens the VCI Manager application. A green badge at the bottom-right corner indicates the VCI device is connected, while a red "X" icon indicates no connection.
MaxiSys Shortcut		Returns to the Diagnostics screen.
Service		Returns to the Service screen.

➤ **To use the camera**

1. Tap the **Camera** icon. The camera screen opens.
2. Focus the image to be captured in the viewfinder.
3. Tap the camera icon on the right side of the screen. The viewfinder now shows and auto-saves the captured photos.
4. Swipe the screen left to view the stored photos.
5. Tap the **Back** or **Home** button to exit the camera application.

 **NOTE**

After swiping the camera screen from left to right, the camera mode and video mode can be toggled by tapping the blue camera icon or video icon.

Refer to your Android software documentation for additional information on using your tablet.

System Status Icons

Your MaxiSys tablet is a fully functional Android tablet with the standard Android operation system status icons. Refer to Android documentation for additional information.

Power Down

All vehicle communications should be terminated before shutting down the tablet. A warning message appears if a shutdown is attempted while the tablet is communicating with the vehicle. Forcing a shutdown while the tablet is communicating with the vehicle may lead to ECU problems on some vehicles. Please exit the Diagnostics application before shutting off the tablet.

- **To power down the MaxiSys tablet**
 1. Press and hold the **Lock/Power** button.
 2. Tap **Power off** option.
 3. Tap **OK**.

Reboot System

In case of a system crash, long press the **Lock/Power** button and tap **Reboot** to restart the system.

4. Diagnostics

The Diagnostics application can access the electronic control unit of multiple vehicle control systems, including but not limited to the engine, transmission, anti-lock brake system (ABS), and airbag system (SRS).

Establish Vehicle Communication

The Diagnostics operations require connecting the MaxiSys Elite II tablet to the test vehicle through the VCI device using the Main Cable (Use the applicable OBDI adapter if needed). To establish proper vehicle communication with the tablet, you need to perform the following steps:

1. Connect the VCI device to the vehicle's DLC for both communication and power source.
2. Connect the VCI device to the tablet via Bluetooth or USB connection.
3. Check the VCI navigation button at the bottom bar on the screen. If a green Bluetooth or USB icon appears at the lower-right corner, the MaxiSys Elite II Diagnostic Platform is ready to start vehicle diagnosis.

Vehicle Connection

The method used to connect the VCI to a vehicle's DLC depends on the vehicle's configuration, as follows:

- A vehicle equipped with an On-board Diagnostics Two (OBDII) management system supplies both communication and 12-volt power through a standardized J-1962 DLC.
- A vehicle not equipped with an OBDII management system supplies communication through a DLC connection, and in some cases supplies 12-volt power through the auxiliary power outlet or a connection to the vehicle battery.

OBDII Vehicle Connection

This type of connection only requires the Main Cable without any additional adapter.

➤ **To connect to an OBDII vehicle**

1. Connect the main cable's female adapter to the Vehicle Data Connector on the

VCI device and tighten the captive screws.

2. Connect the cable's 16-pin male adapter to the vehicle's DLC, which is generally located under the vehicle dashboard.

 **NOTE**

The vehicle's DLC is not always located under the dashboard. Refer to the user manual of the test vehicle for additional connection information.

Non-OBDII Vehicle Connection

This type of connection requires both the main cable and an OBDI adapter for the specific vehicle being serviced.

There are three possible scenarios for Non-OBDII vehicle connection:

- DLC connection supplies both communication and power.
- DLC connection supplies communication and power is supplied via the vehicle's auxiliary power outlet adapter.
- DLC connection supplies communication and power is supplied via the vehicle battery.

➤ **To connect to a Non-OBDII Vehicle**

1. Connect the main cable's female adapter to the Vehicle Data Connector on the VCI device, and tighten the captive screws.
2. Locate the required OBDI adapter and connect its 16-pin jack to the main cable's male adapter.
3. Connect the attached OBDI adapter to the vehicle's DLC.

 **NOTE**

Some vehicles may have more than one adapter or may have test leads instead of an adapter. Make the proper connection to the vehicle's DLC as required.

➤ **To connect the auxiliary power outlet adapter**

1. Plug the DC power connector of the auxiliary power outlet adapter into the DC power supply input port on the device.
2. Connect the male connector of the auxiliary power outlet adapter to the vehicle's auxiliary power outlet.

➤ **To connect the clipper cable**

1. Connect the tubular plug of the clipper cable to the male connector of the auxiliary power outlet adapter.

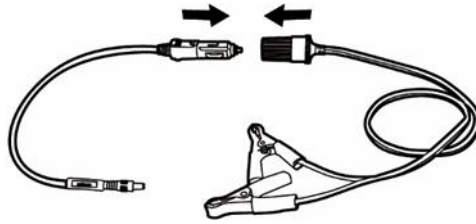

Figure 4-1 Connection between Auxiliary Power Outlet Adapter and Clipper Cable

2. Plug the DC power connector of the auxiliary power outlet adapter into the DC power supply input port of the VCI device.
3. Connect the clipper cable to the vehicle's battery.

NOTE

After the VCI is successfully connected to the vehicle, the Tablet Connection Status LED on the VCI lights, and a beeping sound will be heard.

VCI Connection

After the VCI is properly connected to the vehicle, the Tablet Connection Status LED on the VCI lights, and is ready to establish communication with the tablet.

The VCI supplied with the MaxiSys Elite II tool kit supports two communication methods with the tablet: Bluetooth and USB.

Pairing via Bluetooth

In open areas, the working range for Bluetooth communication is about 328 feet (100 m), giving technicians greater mobility to perform vehicle diagnosis from anywhere in the repair shop.

To expedite multi-vehicle diagnostics, more than one VCI can be used in busy repair shops, enabling technicians to quickly pair their MaxiSys tablet to each VCI via Bluetooth separately and therefore eliminating the need to physically connect the VCI to each vehicle.

➤ To pair the tablet with the VCI device via Bluetooth

1. Power up the tablet.
2. Select the **VCI Manager** application from the MaxiSys Job Menu.
3. When the **VCI Manager** application is launched, the device automatically scans for VCI devices available for Bluetooth pairing. Available VCIs are listed in the Settings

section on the right side of the screen.

 **NOTE**

If no VCI is found, this may indicate that the signal strength is too weak to be detected. Reposition the VCI and remove all possible objects that may cause signal interference. Tap the **Scan** button at the top-right corner to rescan for the VCI.

4. Typically, the VCI name appears as “Maxi” suffixed with the VCI serial number. Select the desired VCI for pairing. (If more than one VCI is used in the shop, ensure the correct VCI is selected.)
5. When pairing is successful, the connection status reads “Connected.”
6. A green "BT" icon will appear on the VCI icon at the bottom of the navigation bar when the tablet and the VCI are connected.

USB Connection

The USB connection is a simple and quick way to establish communication between the tablet and the VCI device. After properly connecting the tablet to the VCI device using the USB cable, the VCI navigation button at the bottom bar of the screen displays USB icon and the Tablet Connection Status LED on the VCI device lights solid green.

The MaxiSys diagnostic platform is now ready to perform vehicle diagnosis.

 **NOTE**

Since the USB connection provides the most stable communication, it is the recommended communication method between the tablet and the VCI when operating ECU programming or coding. The USB communication method will take priority over other communication methods.

No Communication Message

- A. If the tablet is unable to connect to the VCI, an error message appears. An error message indicates the tablet is not communicating with the VCI device. Troubleshoot the error by performing the following steps:
- Ensure the VCI is powered on.
 - When using the wireless connection, ensure the proper VCI has been connected.
 - If the tablet loses communication abruptly during the diagnosis, ensure no objects are causing signal interference.
 - Ensure the VCI device is properly positioned with its front-side up.

- Move the tablet closer to the VCI device. If using the wired connection, ensure the cable is securely attached to the VCI.
 - Ensure the VCI communication mode is lit for the selected communication type, either Bluetooth or USB.
- B. If the VCI device is unable to establish a communication link, a message will display troubleshooting instructions. Possible causes for the communication error include:
- The VCI is unable to establish a communication link with the vehicle.
 - A vehicle system has been selected for diagnosis that is not supported by the vehicle.
 - There is a loose connection.
 - There is a blown vehicle fuse.
 - The vehicle or the data cable has a wiring fault.
 - There is a circuit fault in the data cable or adapter.
 - The VIN entered is incorrect.

Getting Started

Prior to first using of the Diagnostics application, ensure the VCI is properly connected to and is communicating with the tablet. See [VCI Manager](#).

Vehicle Menu Layout

When the VCI is properly connected to the vehicle and the tablet, the platform is ready to start vehicle diagnosis. Tap the **Diagnostics** application button on the MaxiSys Job Menu, the Vehicle Menu will appear on the screen.



Figure 4-2 Vehicle Menu Screen









1. Top Toolbar Buttons
2. Automobile Manufacturer Icons

Top Toolbar Buttons

The operations of the Toolbar buttons at the top of the screen are listed and described in the table below:

Table 4-1 Top Toolbar Buttons

Name	Button	Description
Home		Returns to the MaxiSys Job Menu.
VID Scan		Tap to display a drop-down list. Tap Auto Detect for auto VIN detection. Tap Manual Input to manually enter a VIN or license number. Tap Scan VIN/License to scan the VIN/license number by camera.
All		Displays all the vehicle makes in the vehicle menu.

Name	Button	Description
Favorites		Displays user-favorited vehicle makes.
History		Displays stored test vehicle records. This option provides direct access to previously tested vehicle records. See Vehicle History .
America		Displays the American vehicle menu.
Europe		Displays the European vehicle menu.
Asia		Displays the Asian vehicle menu.
China		Displays the Chinese vehicle menu.
Search		Tap to display the virtual keyboard and enter a vehicle manufacturer.
Cancel		Tap to exit the search screen or cancel an operation.

Automobile Manufacturer Buttons

The Automobile Manufacturer buttons display various vehicle brand names. Select a manufacturer button after the VCI device is properly connected to the test vehicle to start a diagnostics session.

Vehicle Identification

The MaxiSys diagnostics system supports five methods of Vehicle Identification.

1. Auto VIN Scan
2. Manual Input
3. Scan VIN/License
4. Manual Vehicle Selection
5. Alternative Vehicle Identification

AutoVIN Scan

The MaxiSys diagnostics system features the latest VIN-based AutoVIN Scan functions to identify vehicles with just one tap, enabling the technician to quickly identify the exact vehicle and scan its available systems for fault codes.

➤ To perform an AutoVIN Scan

1. Tap the **Diagnostics** application button from the MaxiSys Job Menu. Then the Vehicle Menu appears.
2. Tap the **VID Scan** button on the top toolbar.
3. Select **Auto Detect**. The tablet starts VIN scanning on the vehicle's ECU. Once the test vehicle is successfully identified, the system will guide you to the Vehicle Diagnostics screen.



Figure 4-3 Auto Detect Screen

The Auto VIN function is still available for some vehicle makes after being selected. Select **Automatic Selection** and the system will acquire VIN information automatically or allow users to manually input the VIN.



Figure 4-4 Automatic Selection Screen

Manual Input

For vehicles that do not support the AutoVIN Scan function, the MaxiSys diagnostics system allows you to manually enter the vehicle VIN or license number, or simply take a photo of the VIN sticker or license plate for quick vehicle identification.

➤ **To perform Manual Input**

1. Tap the **Diagnostics** application button from the MaxiSys Job Menu. The Vehicle Menu displays.
2. Tap the **VID Scan** button on the top toolbar.
3. Select **Manual Input**.
4. Tap the input box and enter the correct VIN code or license number.

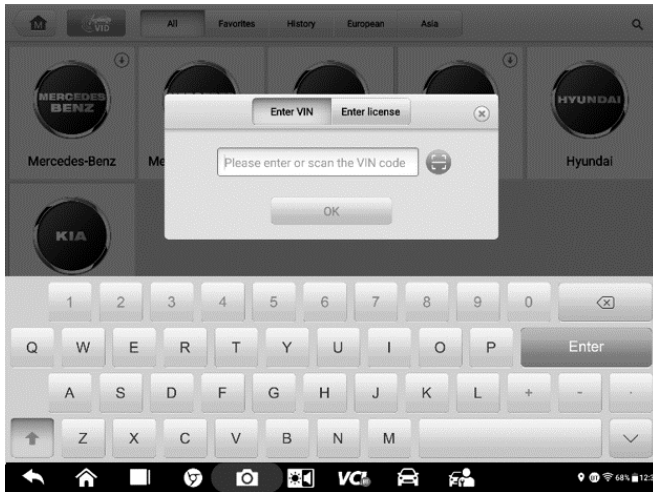

Figure 4-5 Manual VIN Input

5. Tap **OK**. The vehicle will be identified and matched to the vehicle database and the Vehicle Diagnostics screen will appear.
6. Tap the “x” icon on the top-right corner to exit Manual Input.

Scan VIN/License

Tap **Scan VIN/License** (Figure 4-3) in the drop-down list, and the camera will launch. On the right side of the screen, three options are available: **Scan Bar Code**, **Scan VIN**, and **Scan License**.

NOTE

The Scan License option is supported in some countries and areas. If not available, manually enter the license number.

Select one of three options and position the tablet to align the VIN or license number within the scanning window, the result appears in the Recognition result dialog box after scanned. Tap **OK** to confirm the result, and then the vehicle information confirmation screen will appear on the tablet. If all the vehicle information is correct, tap the icon in the middle of the screen to confirm the VIN of the test vehicle. Tap **OK** to continue.

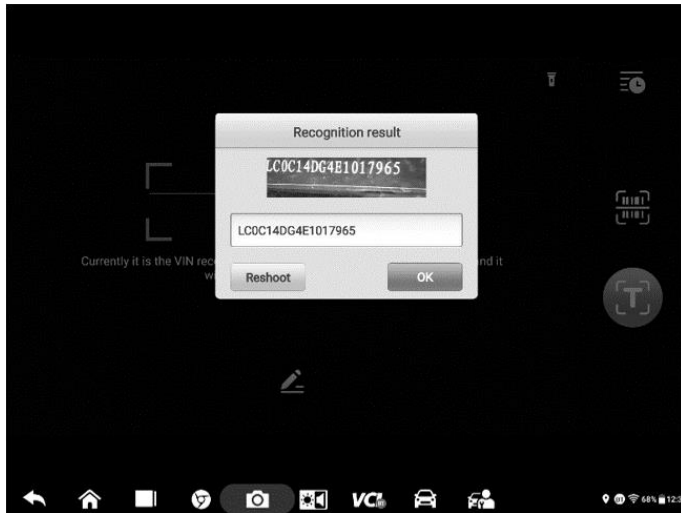

Figure 4-6 Scan VIN Code 1

If the VIN/License number can't be scanned, manually enter it after tapping the pen-shape  icon. Tap **OK** to continue. Manually enter the license number and select a vehicle brand in the vehicle information confirmation screen. Tap the icon in the middle of the screen to confirm the VIN of the test vehicle. Tap **OK** to continue.



Figure 4-7 Scan VIN Code 2

Manual Vehicle Selection

When the vehicle's VIN is not automatically retrievable through the vehicle's ECU or when the specific VIN is unknown, you can select the vehicle manually.

This mode of vehicle selection is menu driven. Select the **Manufacturer** icon on the Vehicle Menu screen and the Select Diagnostic Type screen appears. Then tap the **Manual Selection** button. Select the vehicle information like the Brand, Model, Capacity, Engine Type, and Model Year on the same screen. Each selection you make advances you to the next screen. The **ESC** button at the lower-right corner of the screen will bring you back to the previous screen. Tap the **Reset** button to reselect the vehicle information, if needed.



Figure 4-8 Manual Vehicle Selection Screen

Alternative Vehicle Identification

Occasionally, the vehicle cannot be identified. For these vehicles, the user may perform a generic OBDII or EOBD diagnostics. See [Generic OBDII Operations](#).

Diagnostics Screen Layout

After the vehicle information is selected, tap the **OK** button at the bottom-right corner of the screen to open the Main menu page. This section consists of various commonly used

functions, including Auto Scan and Control Unit. The available functions displayed vary according to vehicle.



Figure 4-9 Vehicle Information Selection Screen



Figure 4-10 Main Menu Screen

Auto Scan

The Auto Scan function performs a comprehensive scanning of all the systems in the vehicle ECU to locate faults and retrieve DTCs. Tap **Fault Scan** to start.

➤ **To perform the Auto Scan function (using Chrysler as an example)**

1. Tap the **Diagnostics** application button on the MaxiSys Job Menu. Choose the corresponding vehicle information and enter the Vehicle Diagnostics page.
2. Select **Auto Scan** on the Main menu to enter the diagnostics interface.
3. Tap the **Fault Scan** button at the bottom of the screen to scan the vehicle system modules.
4. The number of total faults will appear on the upper-right corner.



Figure 4-11 Auto Scan Screen

NOTE

On the Auto Scan screen, there is a **Select System** icon  on the upper-right corner. Selecting the corresponding system(s) to scan can save more time than scanning all systems.

1. Diagnostics Toolbar
2. Current Directory Path

3. Status Information Bar







4. Main Section

5. Functional Buttons

Diagnostics Toolbar

The Diagnostics Toolbar contains buttons that allow you to print or save the displayed data and perform other operations. The following table provides a brief description for the operations of the Diagnostics toolbar buttons:

Table 4-2 Diagnostics Toolbar Buttons

Name	Button	Description
Home		Returns to the MaxiSys Job Menu.
Vehicle Swap		Exits the diagnostics session and returns to the vehicle menu screen to select another vehicle for testing.
Settings		Opens the Settings screen. See Settings .
Print		Saves and prints a copy of the displayed data. See Printing Settings .
Help		Provides instructions or tips for operations of various diagnostic functions.
Save		Opens a submenu for the 2 options to save data: Tap Save This Page to take a screenshot image Tap Save All Data to save a PDF file (use this option when data displays on multiple screens) These files are stored in the Data Manager application for later reviews. See Data Manager .
Data Logging		Tap to display the error options. Select a specific abnormal type, and a submission form will appear to let you enter the report information.

➤ **To print data in Diagnostics**

1. Tap the **Diagnostics** application button on the MaxiSys Job Menu. The **Print** button in the diagnostics toolbar is available throughout the Diagnostics operations.
2. Tap **Print** and a drop-down menu displays.
 - **Print This Page** — prints a screenshot copy of the current screen.
 - **Print All Data** — prints a PDF copy of all displayed data.
3. A temporary file will be created and sent via the computer to the printer.
4. When the file is sent, a confirmation message displays.

 **NOTE**

Make sure the tablet and the printer are connected either by Wi-Fi or LAN before printing. For more instructions on printing, see [Printing Settings](#).

➤ **To submit Data Logging reports in Diagnostics**

1. Tap the **Diagnostics** application button from the MaxiSys Main Screen. The **Data Logging** button on the diagnostics toolbar is available throughout the Diagnostics operations.
2. Tap the **Data Logging** button to display the error options. Select a specific error, and a submission form will appear to let you enter the report information.
3. Tap the **Send** button on the upper-right corner of the screen to submit the report via the Internet, and a confirmation message appears when sent successfully.

Current Directory Path

The Directory Path shows all directory names to access the current page.

Status Information Bar

The Status Information Bar at the top of the Main Section displays the following items:

- **VCI** Icon — indicates the communication status between the tablet and the VCI device.
- **Battery** Icon — indicates the battery status of the vehicle.

Main Section

The Main Section varies depending on the stage of operations which shows vehicle identification selections, the main menu, test data, messages, instructions, and other diagnostics information.

The Main Section of Auto Scan screen displays a System List for all vehicles.

System List Tab Page

- Column 1 — displays the system numbers.
 - Column 2 — displays the scanned systems.
 - Column 3 — displays the scan results.
- ❖ **-!-**: Indicates that the scanned system may not support the code-reading function, or there is a communication error between the tester and the control system.
 - ❖ **-?-**: Indicates that the vehicle control system has been detected, but the tester cannot access it.
 - ❖ **Fault | #**: Indicates there is/are fault code(s) detected; “#” indicates the quantity of detected faults.
 - ❖ **Pass | No Fault**: Indicates the system was scanned and no faults detected.
 - ❖ **Not Scanned**: Indicates the system has not been scanned.
 - ❖ **No Response**: Indicates the system has not received a response.



Figure 4-12 System List Tab Page

- Column 4 — tap to enter the related system and view the detailed information.

Function Buttons

The type of function buttons displayed at the bottom of the screen vary by operation. Functions include pause, reporting, code clearing, exit scanning, and other function controls.

The table below provides a brief description of how the function buttons operate:

Table 4-3 Function Buttons in Diagnostics Screen

Name	Description
Report	Displays the diagnostic data in the report form.
Quick Erase	Erases all fault information after scanning.
Fault Scan	Scans vehicle system modules for fault codes.
Pause	Pauses the scanning process.
Enter System	Enters the ECU system.
ESC	Returns to the previous screen or exits the Diagnostics Screen.

Select one of the system modules from the System list and tap **Enter System** to enter the specific system functions.

NOTE

The Diagnostic Toolbar Buttons (located on the top of the screen) will be activated throughout the diagnostic session for tasks such as printing and saving the displayed data, obtaining help information, and logging data.

Control Unit

The Control Unit allows you to manually locate a required control system for testing through a series of choices. Follow the menu-driven procedure, and the program will guide you to the Diagnostic Function menu.

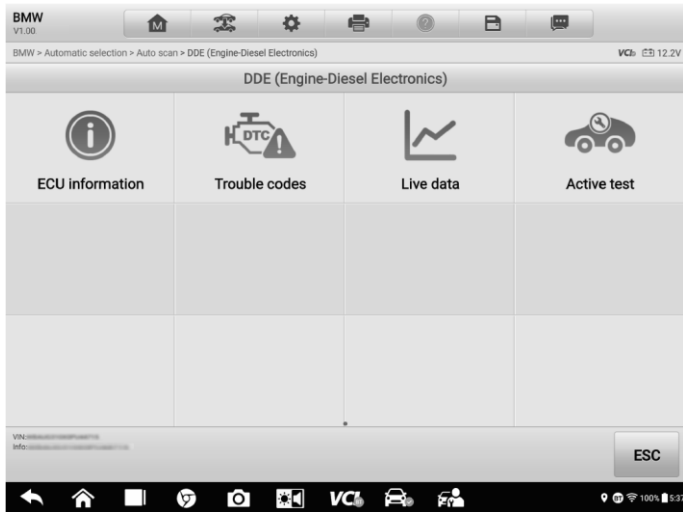

Figure 4-13 Function Menu Screen

Available functions may vary by vehicle. The function menu may include:

- **ECU Information** — displays detailed ECU information. Select to view the information screen.
- **Trouble Codes** — contains Read Codes and Erase Codes. The former displays detailed DTC information retrieved from the vehicle control modules; the latter allows you to erase DTCs and other data from the ECU.
- **Live Data** — retrieves and displays live data and parameters from the vehicle's ECU.
- **Active Tests** — provides specific subsystem and component tests. This selection may display as *Actuators*, *Actuator Test* or *Function Tests*. Available tests vary by vehicle.
- **Special Functions** — provides component adaptation or variant coding functions for custom configurations, and allows entry of adaptive values for certain components after repairs. Depending on the test vehicle, this selection may sometimes appear as *control Unit Adaptations*, *Variant Coding*, *Configuration* or something similar.

Screen Messages

Messages appear when additional input is needed before proceeding. There are mainly three types of on-screen messages: Confirmation, Warning, and Error.

- **Confirmation Messages**

This type of message usually appears as an "Information" screen, when you are about to perform an action that cannot be reversed or when an action has been initiated and your confirmation is needed to continue.

When a user-response is not required, the message only appears briefly before disappearing.

- **Warning Messages**

This type of message appears when completing the selected action may result in an irreversible change or loss of data. An example of this message is the "Erase Codes" message.

- **Error Messages**

Error messages appear when a systemic or procedural error has occurred. Possible errors include cable disconnection and communication interruption.

Making Selections

The Diagnostics application is a menu-driven program that presents a series of options one at a time. As you select from a menu, the next menu in the series appears. Each selection narrows the focus and leads to the desired test. Use your fingertip to make menu selections.

ECU Information

This function retrieves and displays the specific information for the tested control unit, including unit type and version numbers.



Figure 4-14 ECU Information Screen

1. Diagnostics Toolbar Buttons — see [Table 4-2 Diagnostics Toolbar Buttons](#) for detailed descriptions of the operations of each button.
2. Current Directory Path
3. Status Information Bar
4. Main Section — the left column displays the item names, and the right column displays the specifications or descriptions.
5. Function Button — in this case, only the **ESC** button is available. Tap it to exit after viewing.

Trouble Codes

Read Codes

This function retrieves and displays DTCs from the vehicle control system. The Read Codes screen varies for each vehicle being tested. For some vehicles, freeze frame data can also be retrieved for viewing. A sample Read Codes screen appears below:



Figure 4-15 Read Codes Screen

1. Diagnostics Toolbar — see [Diagnostics Toolbar Buttons](#) for details.
2. Current Directory Path
3. Status Information Bar
4. Main Section
 - Column 1 — displays the retrieved codes from the vehicle.
 - Column 2 — indicates the status of the retrieved codes.
 - Column 3 — detailed descriptions for the retrieved codes.
5. Function Buttons
 - **DTC Guide** — tap to enter the DTC guide screen to check related repair cases and help information.

- **Freeze Frame** —  icon appears when freeze frame data is available for viewing. Tap the icon to display the data screen. The Freeze Frame screen is similar to that of the Read Codes interface and shares similar operations.
- **Search** — tap to search the selected DTC for additional information on the Internet.
- **Erase Codes** — tap to erase codes from the ECU. It is recommended that DTCs are read and needed repairs are performed before erasing codes.
- **Read Codes** — retrieves and displays the DTCs from the vehicle control system. The Read Codes screen varies for each vehicle being tested.
- **ESC** — tap to return to the previous screen or exit the function.

Erase Codes

After reading the retrieved codes from the vehicle and making repairs, you can erase the codes from the vehicle using this function. Before performing this function, make sure the vehicle's ignition key is in the ON (RUN) position with the engine off.

➤ To erase codes

1. Tap **Erase codes** in the Function Menu.
2. A warning message appears to inform you of data loss when this function is applied.
 - a) Tap **Yes** to continue. A confirmation screen appears when the operation is successfully done.
 - b) Tap **No** to exit.
3. Tap **ESC** on the confirmation screen to exit Erase Codes.
4. Check the Read Codes function again to ensure the operation is successful.

Live Data

When this function is selected, the screen displays the data list for the selected module. The parameters appear in the order that they are transmitted by the ECU, so expect variation among vehicles.

Gesture scrolling allows you to quickly move through the data list. Drag your finger up or down on the screen to reposition the parameters being displayed if the data occupies more than one screen. The figure below displays a typical Live Data screen:

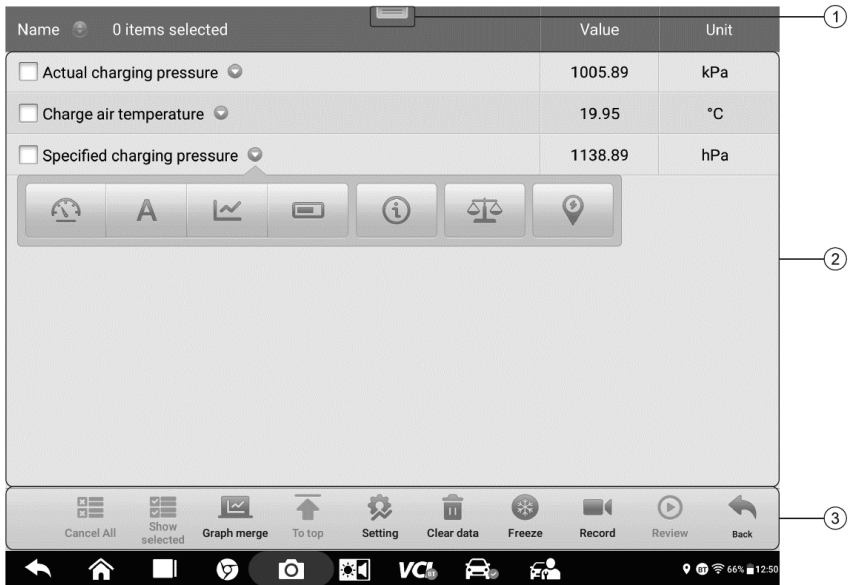

Figure 4-16 Live Data Screen

1. **Diagnostics Toolbar Buttons** — tap the toolbar menu icon at the top of the screen to display diagnostics toolbar buttons. See [Diagnostics Toolbar Buttons](#) for detailed descriptions for each button.
2. **Main Section**
 - Name Column — displays the parameters.
 - a) Check Box — tap the check box to the left of a parameter to select the item. Tap the check box again to deselect it.
 - b) Drop-down menu — tap the drop-down menu on the right side of a parameter to open a submenu, which provides optional modes that display the data.
 - Value Column — displays the value of the parameters.
 - Unit Column — displays the unit of the parameter values. To change the Unit mode, tap the **Settings** button in the top toolbar and select the required mode. See [Unit](#).

Display Mode

There are four display modes available for data viewing, allowing you to view various types of parameters in the most suitable way.

Tap the drop-down menu on the right side of a parameter to open a submenu. A total of 7 buttons will be displayed: The 4 buttons on the left represent different data display modes, plus an **Information** button (active when additional information is available), and a **Unit Change** button (for switching the unit of the displayed data), and a **Trigger** button (tap to open the **Trigger Settings** window).



Figure 4-17 Display Mode Screen

Each parameter displays the selected mode independently.

- ✧ **Analog Gauge Mode** — displays the parameters in gauge charts.
- ✧ **Text Mode** — the default mode that displays the parameters as a text list.

NOTE

Some status parameters, such as a switch reading like ON, OFF, ACTIVE, and ABORT, can only be displayed in Text Mode. Others, such as a sensor reading, can be displayed in both text and graph modes.

- ✧ **Waveform Graph Mode** — displays the parameters in waveform graphs.

In this mode, five control buttons will appear on the right side of the parameter, allowing you to operate the display status.

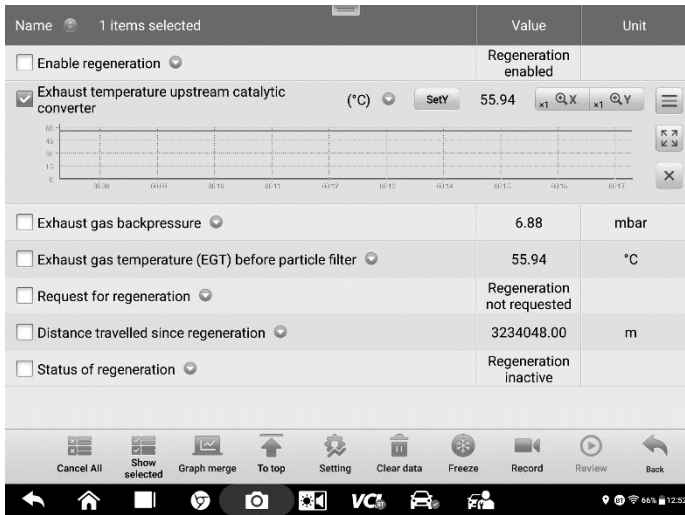

Figure 4-18 Waveform Graph Mode Screen

1. **Settings Button (SetY)** — sets the minimum and maximum value of the Y axis.
2. **Scale Button** — changes the scale values.

There are two scale buttons displaying above the waveform graph to the right side, which can be used to change the scale values of the X-axis and Y-axis of the graph. There are four scales available for the X-axis: x1, x2, x4 and x8, and three scales available for the Y-axis: x1, x2, and x4.

3. **Edit Button** — edit the waveform color and line thickness.
4. **Zoom-in Button** — tap to display the selected data graph in full screen.
5. **Exit Button** — tap to exit the waveform graph mode.

◇ **Full Screen Display** — this option is only available in the waveform graph mode, and is mostly used in Graph Merge status for data comparison. There are 4 control buttons available on the top-right side of the screen under this mode.

- **Scale Button** — tap to change the scale values below the waveform graph. There are four scales available for the X-axis: x1, x2, x4 and x8. There are three scales available for the Y-axis: x1, x2, and x4.
- **Edit Button** — tap to open an edit window, in which you can set the waveform color and the line thickness displayed for the selected parameter.
- **Zoom-out Button** — tap to exit full screen display.
- **Exit Button** — tap to exit the waveform graph mode.

➤ **To edit the waveform color and line thickness in a data graph**

1. Select a parameter to display in Waveform Graph mode.
2. Tap the **Edit** button and an edit window will appear.

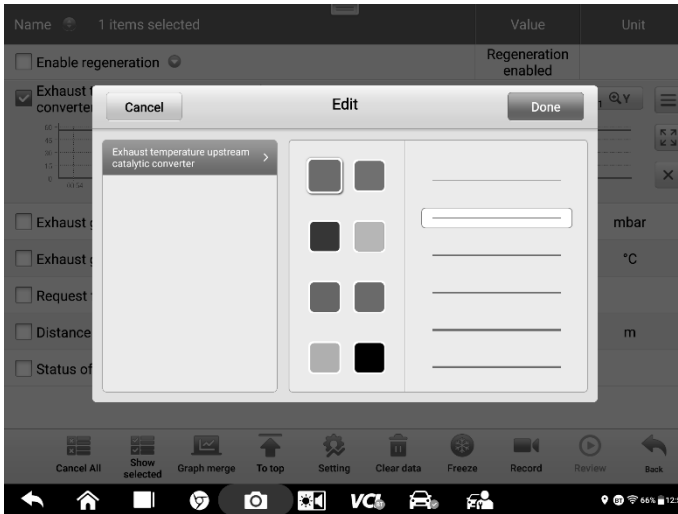

Figure 4-19 Waveform Edit Screen

3. The parameter is selected automatically in the left column.
4. Select a color from the second column.
5. Select a line thickness from the right column.
6. Tap **Done** to save the settings and exit, or tap **Cancel** to exit without saving.

NOTE

In full-screen display, you can edit the waveform color and line thickness by tapping the **Edit** button on the upper-right side of the screen.

✦ **Digital Gauge Mode** — displays the parameters in the form of a digital gauge graph.

Trigger Settings

Tap the drop-down button on the right side of the parameter to open a submenu. The **Trigger** button is the last one in the submenu. Tap to display the **Trigger Settings** window.

On the **Trigger Settings** screen, you can set a standard range by filling in a minimum

value and a maximum value. When exceeding this range, the trigger function will be executed and the device will automatically record and save the generated data. You can review the saved live data by tapping the **Review** button at the bottom of the screen.

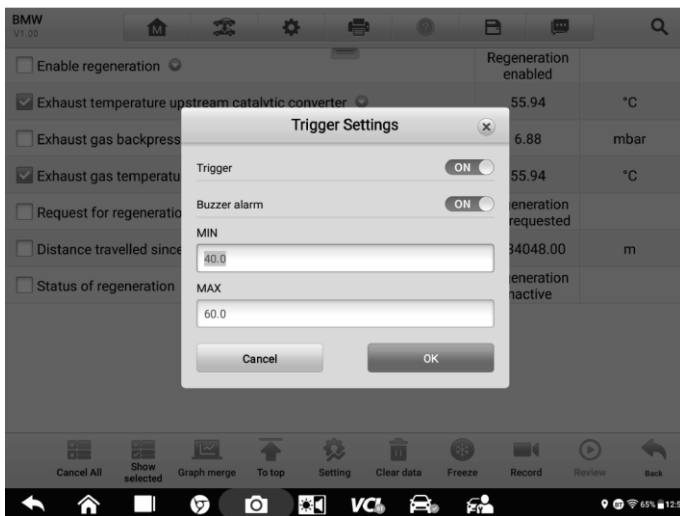

Figure 4-20 Trigger Settings Screen

Two buttons and two input boxes are available in the Trigger Settings window.

- a) **Trigger** — switches the trigger on and off. The trigger is ON by default.
- b) **Buzzer Alarm** — switches the alarm on and off. The alarm function makes a beeping sound as an alert when the data reading reaches the preset minimum or maximum value. The buzzer alarm will only sound at the first trigger.
- c) **MIN** — tap this input box to display a virtual keyboard to enter the required lower threshold value.
- d) **MAX** — tap this input box to display a virtual keyboard to enter the required upper threshold value.

➤ **To set a trigger**

1. Tap the drop-down button on the right side of the parameter to open a submenu.
2. Tap the **Trigger** button on the right side of the submenu to open the **Trigger Settings** window.
3. Tap the **MIN** input box and enter the required minimum value.

4. Tap the **MAX** input box and enter the required maximum value.
5. Tap **OK** to save the settings and return to the Live Data screen or tap **Cancel** to exit without saving.

When the trigger is set, a trigger mark appears in front of the parameter. The mark is grayed out when it is not triggered, and orange when triggered. Moreover, two horizontal lines appear on each of the data graphs (when Waveform Graph Mode is applied) to indicate the alarm point. The threshold lines are shown in different colors to differentiate them from the parameter waveforms.

3. Function Buttons

The operations of all available function buttons on the Live Data screen are described below:

- ✧ **Cancel All** — tap to cancel all selected parameter. Up to 50 parameters can be selected at one time.
- ✧ **Show Selected/Show All** — tap to switch between the two options: one displays the selected parameters, the other displays all the available items.
- ✧ **Graph Merge** — tap to merge selected data graphs (for Waveform Graph Mode only). This function is very useful when comparing different parameters.

NOTE

This mode supports Graph Merge of 2 to 5 digital parameters. Non-digital parameters are not supported.

➤ **To merge selected data graphs**

- 1) Select parameters to be merged.
- 2) Tap the **Graph Merge** button at the bottom of the Live Data screen.
 - a) This mode only supports parameters that can be represented digitally. If non-digital parameters are selected, a message will appear advising the user that the selected parameters are not supported in this mode and to select 2 to 5 digital parameters. Tap **Got It** to return to the previous screen and select supported parameters.
 - b) If unsupported parameters are selected in this mode, a message will appear advising the user to only select the supported parameters. A message will also appear if more than 5 parameters are selected. Select 2 to 5 of the supported parameters and tap the **OK** button to merge.
- 3) Tap the **Cancel Merging** button at the bottom of the Live Data screen to cancel merge.

- ❖ **To Top** — moves a selected data item to the top of the list.
- ❖ **Setting** — tap to set recording duration. Eleven options are available: 5 seconds, 15 seconds, 30 seconds, 60 seconds, 90 seconds, 3 minutes, 5 minutes, 10 minutes, 20 minutes, 30 minutes, and 60 minutes.
- **To set the live data record duration**
 1. Tap the **Settings** button at the bottom of the Live Data screen.
 2. Tap the > button to the right of **Recording time after trigger** bar and select a time length.
 3. Tap **OK** to save the settings and return to the Live Data Settings screen, or tap the “X” button on the upper-right corner to exit without saving.
 4. Tap **Done** at the upper-right corner of the Live Data Settings screen to confirm and save the settings, and return to the Live Data screen, or tap **Cancel** to exit without saving.
- ❖ **Clear Data** — tap to clear all cached live data.
- ❖ **Freeze** — displays the retrieved data in freeze mode.
 - Previous Frame — moves to the previous frame of frozen data.
 - Next Frame — moves to the next frame of frozen data.
 - Play/Pause — tap to play/pause the frozen data.
 - Resume — tap to exit the freeze data mode and return to normal data display.
- ❖ **Record** — starts recording the live data of the selected data items. Tap the **Record** button at the bottom of the Live Data screen. A message will display prompting the user to select parameters to record. Tap the **Got It** button to confirm. Scroll down and select data to record. Tap the **Record** button to start recording. Tap the **Resume** button to stop recording. The recorded live data can be viewed in the **Review** section at the bottom of the Live Data screen or in the Data Manager application.
 - Resume — tap to stop data recording and return to normal data display.
 - Flag — this button appears when the Record function is applied. Tap to set flags to note points of interest when recording data. Notes can be added during playback in Review or Data Manager. Select the preset flag to open a pop-up window and display a virtual keyboard to input notes.
- ❖ **Review** — review the recorded data. Tap the **Review** button to display a recording list and select an item to review.

NOTE

Only data recorded during the current operation can be reviewed on the Live Data screen. All historical recorded data can be reviewed in Review in the Data Manager application.

- Previous Frame — switches to the previous frame of the recorded data.
- Next Frame — switches to the next frame of the recorded data.
- Play/Pause — tap to play/pause the recorded data.
- Show Selected — displays the selected parameters.
- Graph Merge — merges the selected data graphs.
- Back — exits the Review and returns to the Live Data screen.

◇ **Back** — returns to the previous screen or exits the function.

Active Test

The Active Test function is used to access vehicle-specific subsystem and component tests. Available tests vary by vehicle.

During an active test, the tablet sends commands to the ECU to activate the actuators. This test determines the integrity of the system or part by reading ECU data or by monitoring the operation of the actuators. Such tests may include toggling a solenoid, relay, or switch, between two operating states.

Selecting Active Test displays a menu of test options. Available tests vary by vehicle. Select test from the menu options. Follow the instructions displayed on the screen to complete the test. Procedures and instructions vary by vehicle.

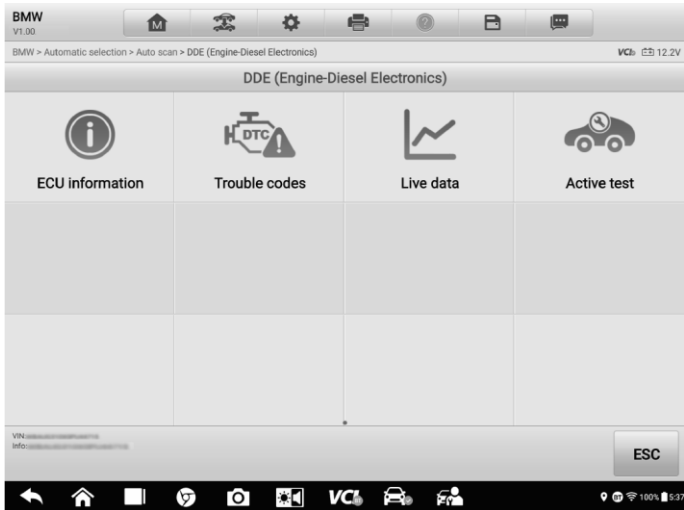

Figure 4-21 Active Test Screen 1



Figure 4-22 Active Test Screen 2

The function buttons on the lower-right corner of the Active Test screen manipulate the test signals. The operational instructions are displayed in the main section of the test screen. Follow the on-screen instructions and make appropriate selections to complete the tests.

Tap the **ESC** button to exit the test when finished.

Special Functions

These functions perform various component adaptations, including the recalibration or configuration of certain components after repairs or replacements have been completed.

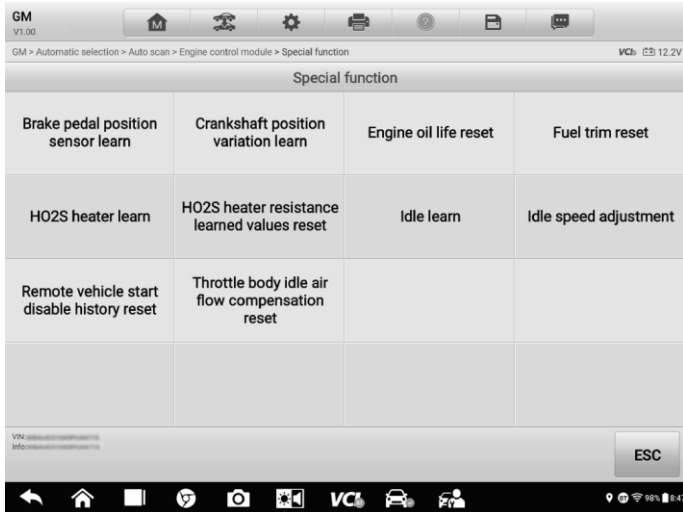

Figure 4-23 Special Function Screen 1

Select a function to display detailed information and the execution screen.

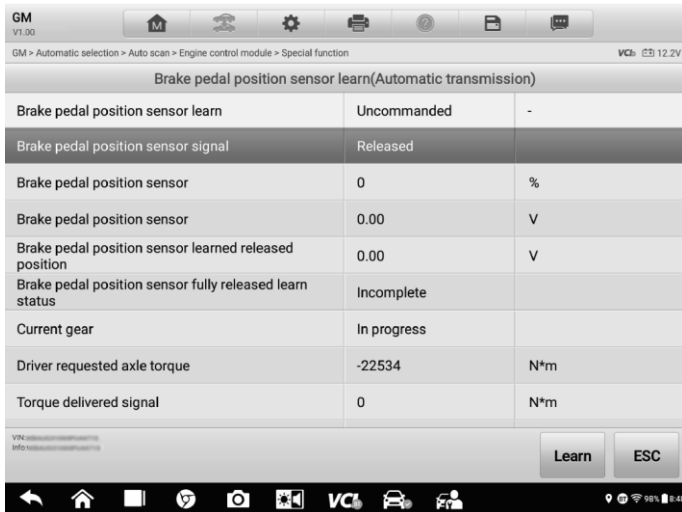

Figure 4-24 Special Function Screen 2

List Tab Page

- Column 1 — displays the description of the function being performed or displays live data corresponding to the special function
- Column 2 — displays the execution status such as “Completed” or “Activated” or may display live data values that correspond to the special function
- Column 3 — displays the measurement units of the live data

Tap the function buttons to perform the selected function or exit the function.

Programming and Coding

Since the introduction of OBDII and leading up to modern Hybrids and EVs, hardware and software technologies in cars have been advancing at an exponential rate. Updating software may be the only way to fix the following issues:

- Drivability
- Fuel Efficiency
- Power Loss
- Fault Codes
- Durability of Mechanical Parts

The Programming and Coding function is used to “re-flash” the vehicle control modules, which allows you to update the computer software of the vehicle to the latest version, as well as to reprogram adaptive data of certain components after making repairs or replacements.

 **NOTE**

The programming function applies only when the vehicle is connected with a VCI device, which serves as a PassThru interface to establish communication with and transfer data to the vehicle's ECU.

Available programming or coding operations vary by test vehicle. Only the available operations display in the tablet menu.

There are two general types of programming operations:

- A. Coding — also known as *Teach-in Program*, or *Component Adaptation*, is used to reprogram adaptive data for vehicle control modules after repairs or replacements of vehicle parts.
 - B. Reprogramming — downloads the latest version of software from the online server database via the Internet access (this procedure is done automatically when the tablet is connected to the Internet, so there is no need to check for software updates yourself), and reprograms the newest version into the vehicle's ECU.
-

 **NOTE**

Ensure that the tablet is connected to a stable internet access before launching the ECU programming function, so that the tablet is able to obtain access to the vehicle manufacturer's server for update service.

Selecting the Programming or Coding function opens a menu of operation options that varies by vehicle make and model. Selecting a menu option either displays a programming interface or opens another menu of additional choices. Follow all screen instructions while performing the programming or coding operations. How and what information is presented on the screen vary by the type of operation being performed.

Coding

The main section of the Coding screen displays a list of vehicle components and the coding information that mainly consists of two parts:

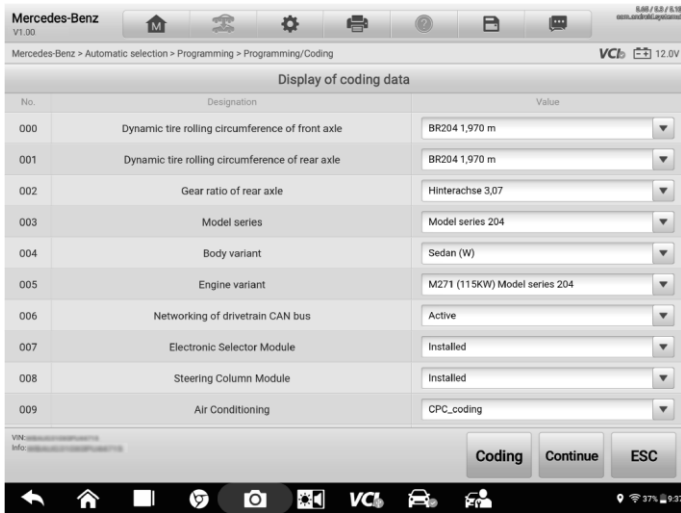

Figure 4-25 Coding Screen

1. All available systems for coding are displayed on the left side, and the coding data or value on the right side.
2. The bottom of the main section displays the functional buttons that enable you to manipulate the operation.

Check the vehicle condition and the coding information carefully. Use the function button to edit codes for the corresponding components. Tap **Send** when you finish editing all items. When the operation is completed, an execution status message, such as Completed, Finished or Successful, may appear.

Tap the **ESC** button to exit the function.

Reprogramming

Before reprogramming begins

- Tablet must be connected to a stable Wi-Fi network.
- Tablet must be connected to the VCI by USB.
- Tablet battery must be fully charged during module programming. Connect tablet to a charger if needed.
- Attach battery maintainer to vehicle battery to ensure a steady voltage is maintained throughout programming. Voltage requirements differ by vehicle manufacturer. Consult vehicle manufacturer recommendations prior to programming a module.
- Do not quit the application during module programming as the process may fail and may also result in permanent damage to the module.

Typical reprogramming operations require you to input and validate the VIN number first. Tap the input box and enter the correct number. The programming interface then appears.

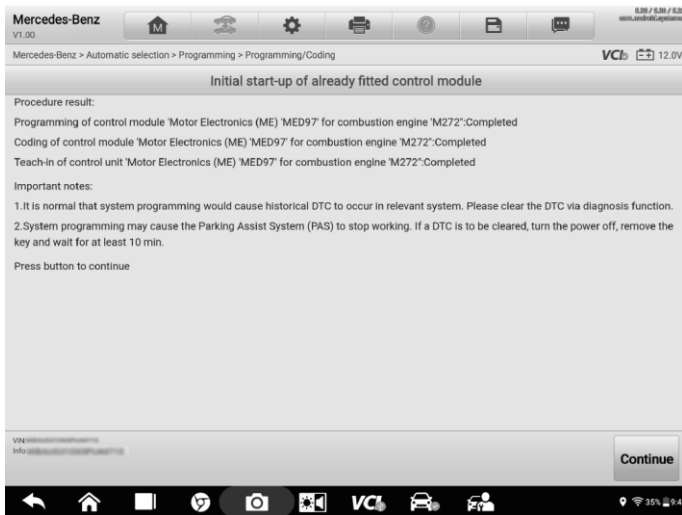

Figure 4-26 *Reprogramming Operation Screen*

The main section of the reprogramming interface offers information about the hardware, the current software version and the newest software versions to be programmed into the control units.

A series of on-screen operational instructions will display to guide you through the programming procedure.

Carefully read the on-screen information and follow the instructions to execute the programming procedure.

Re-flash Errors

! IMPORTANT

When reprogramming onboard, always make sure the vehicle battery is fully charged and in good working condition. During reprogramming, the operation may fail if voltage falls below the proper operation voltage. Sometimes a failed operation can be recovered, but the failed reprogramming can also ruin the control module. We recommend connecting an external battery maintainer to the vehicle to ensure a steady voltage is maintained throughout programming. The required voltage differs by vehicle manufacturer. Consult vehicle manufacturer for correct voltage to be maintained.

Occasionally a flash update procedure may not be completed properly. Common causes of flash errors include poor cable connections between the tablet, VCI, and vehicle, the vehicle ignition being switched off before the flash procedure is completed, or low vehicle battery voltage.

If the process quits, recheck all cable connections to assure good communications and initialize the flash procedure. The programming procedure will automatically repeat if the previous operation does not succeed.

Generic OBDII Operations

The OBDII/EOBD vehicle diagnosis option offers a quick way to check for DTCs, isolate the cause of an illuminated malfunction indicator lamp (MIL), check monitor status prior to emissions certification testing, verify repairs, and perform other emissions-related services. The OBDII direct access option is also used for testing OBDII/EOBD-compliant vehicles that are not included in the diagnostics database. Diagnostics toolbar buttons at the top of the screen are available for specific vehicle diagnostics. See [Table 4-2 Diagnostics Toolbar Buttons](#) for details.

General Procedure

➤ To access the OBDII/EOBD diagnostics functions

1. Tap the **Diagnostics** application button in the MaxiSys Job Menu. The Vehicle Menu appears.

2. Tap the **EOBD** button. There are two options to establish communication with the vehicle.
 - Auto Scan — tap to establish communication using each protocol in order to determine which one the vehicle is using.
 - Protocols — tap to open a submenu of various protocols. A communications protocol is a standardized way of data communication between an ECM and a diagnostics tool. Global OBD may use several different communications protocols.
3. Select a specific protocol if the **Protocols** option is selected. Wait for the OBDII Diagnostic Menu to appear.



Figure 4-27 OBDII Diagnostic Menu

4. Select a function option to continue.
 - DTC & FFD
 - I/M Readiness
 - Live Data
 - O₂ Sensor Monitor
 - On-Board Monitor
 - Component Test
 - Vehicle Information

- Vehicle Status

NOTE

Supported functions may vary by vehicle.

Function Descriptions

This section describes various functions of each diagnostics option.

DTC & FFD

When this function is selected, the screen displays a list of current codes and pending codes. When the Freeze Frame data of certain DTCs are available for viewing, a snowflake button will display on the right side of the DTC item. The Erase Codes function can be applied by tapping the function button at the bottom of the screen.

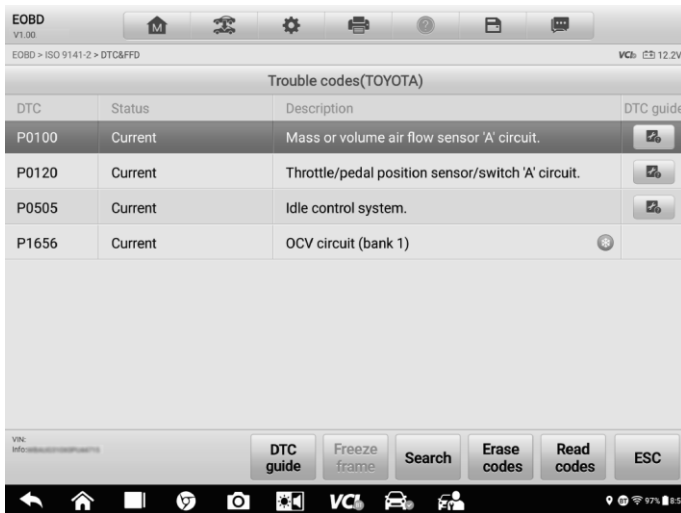

Figure 4-28 DTC & FFD Screen

- **Current Codes**

Current codes are emission-related DTCs from the ECU of the vehicle. OBDII/EOBD Codes are prioritized according to their emission severity, with higher-priority codes overwriting lower-priority ones. The priority of the code determines the illumination of the

Malfunction Indicator Light (MIL) and the codes erase procedure. Manufacturers rank codes differently, so DTCs may vary by vehicle.

- **Pending Codes**

These are codes whose storing conditions have been met during the last drive cycle, but need to be met on two or more consecutive drive cycles before the DTC is stored. The purpose of displaying pending codes is to assist the service technician after a vehicle repair when diagnostic information is cleared, by reporting test results after a single driving cycle.

- ◆ If a test fails during the driving cycle, the DTC associated is reported. If the pending fault does not occur again within 40 to 80 warm-up cycles, the fault is automatically cleared from memory.
- ◆ Test results reported do not necessarily indicate a faulty component or system. If test results indicate another failure after additional driving, a DTC is stored to indicate a faulty component or system.

- **Freeze Frame**

In most cases the stored frame is the last DTC reported. Certain DTCs — those that have a greater impact on vehicle emission — have a higher priority. In these cases, DTC of the highest priority is the one for which the freeze frame records are retained. Freeze frame data includes a “snapshot” of critical parameter values at the time the DTC is stored.

- **Erase Codes**

This option is used to clear all emission-related diagnostics data including DTCs, freeze frame data and specific manufacturer-enhanced data from the vehicle ECU. This option resets the I/M Readiness Monitor Status for all vehicle monitors to Not Ready or Not Complete status.

A confirmation screen displays when the clear codes option is selected to prevent accidental loss of data. Tap Yes on the confirmation screen to continue, or No to exit.

I/M Readiness

This function is used to check the readiness of the monitoring system. It is an excellent function to use prior to having a vehicle inspected for state emissions compliance. Selecting I/M Readiness opens a submenu with two choices:

- Since DTCs Cleared — displays the status of monitors since the last time the DTCs were erased.
- This Driving Cycle — displays the status of monitors since the beginning of the current drive cycle.

Live Data

This function enables the display of real-time PID data from the ECU. Displayed data includes analog and digital input and output, and system status information broadcast in the vehicle data stream.

Live data can be displayed in various modes, see [Live Data](#) for detailed information.

O₂ Sensor Monitor

This function allows retrieval and review of recent O₂ sensor monitor test results stored on the vehicle on-board computer.

The O₂ Sensor Monitor test function is not supported by vehicles that communicate using a controller area network (CAN). For O₂ Sensor Monitor tests results of CAN-equipped vehicles.

On-Board Monitor

This function allows you to view the results of On-Board Monitor tests. The tests are useful after the service when a vehicle control module memory is already erased.

Component Test

This function enables dual-directional control of the ECU so that the diagnostics tool can transmit control commands to operate the vehicle systems. This function is useful in determining how well the ECU responds to a command.

Vehicle Information

This function enables the display of the vehicle identification number (VIN), calibration identification number, calibration verification number (CVN), and other information of the test vehicle.

Vehicle Status

This function checks the current condition of the vehicle, such as the communications protocols of OBDII modules, number of fault codes, and status of the Malfunction Indicator Light (MIL).

Diagnostics Report

Pre-Scan and Post-Scan

➤ **To perform the pre-scan and post-scan functions**

1. Auto scan the Vehicle — the Auto VID function can automatically identify the vehicle and its equipped systems. All available modules in all systems will be scanned automatically. Codes and their details will be listed.
2. Print Pre-scan Report — vehicle images can be taken with tablet and attached to scan report. The report can be generated and submitted. The report can be customized with shop and vehicle information.
3. Repair Vehicle — creates efficient repair plan from the start.
4. Auto scan Repaired Vehicle — ensures no new faults were created during repair and no DTCs are present at completion.
5. Print Post-scan Report — proves all DTCs on Pre-SCAN report are repaired.

Diagnostics Report PDF

The diagnostics report can be reviewed, saved, and printed in multiple applications of the platform.

- a) Via the **History** function:

- Enter the Diagnosis main page, and tap **History** in the Top Toolbar.

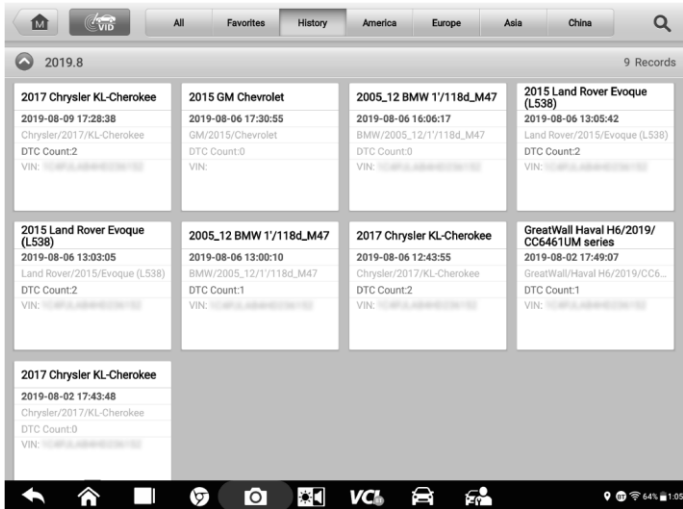

Figure 4-29 History Screen

- Select a history record and tap the **...** button on the upper-right corner to view the PDF document, print, email or delete the test record.

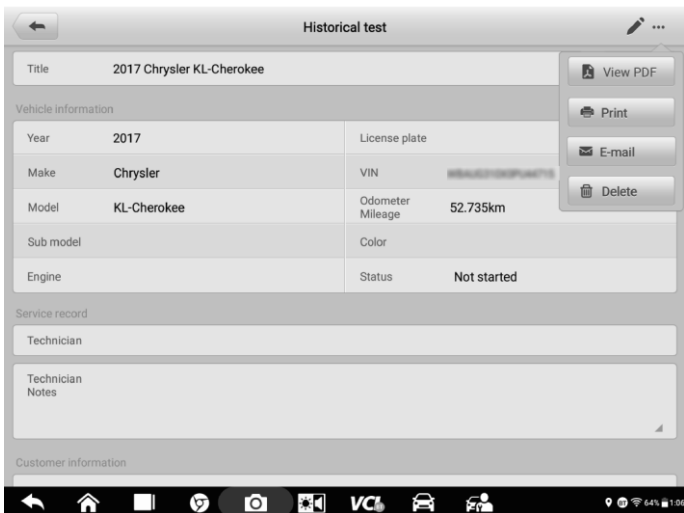

Figure 4-30 Test Record Screen

b) Via the **Auto Scan** function:

- Enter the Auto Scan page and tap **Fault Scan** in the function button bar at the bottom of the screen.

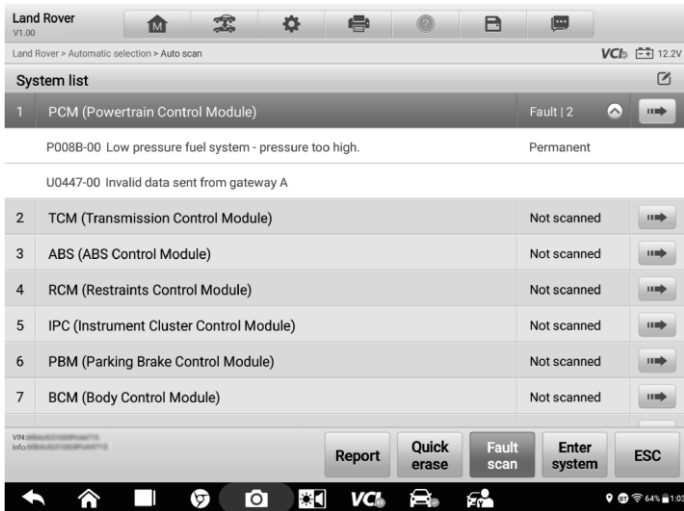

Figure 4-31 Auto Scan Screen 1

- When the system scan is completed, tap **Report** in the function button bar at the bottom of the screen.

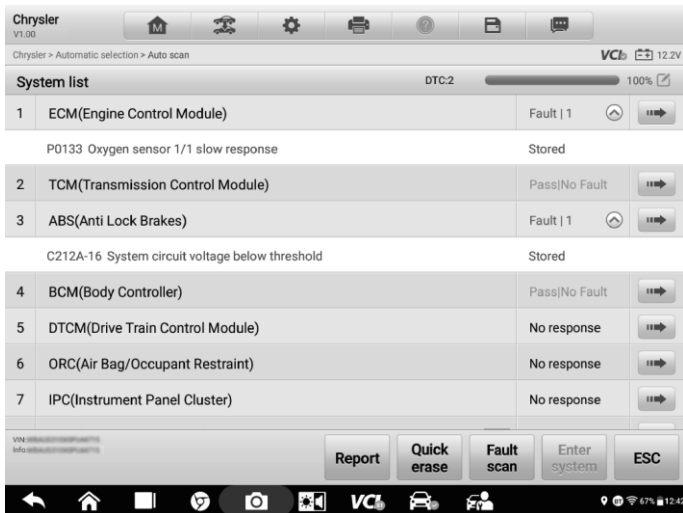

Figure 4-32 Auto Scan Screen 2

- Tap the  button in the Diagnostics Toolbar and select **Save all data** to save the PDF document or select **Save this page** to save the screenshot of the current page.



Figure 4-33 Auto Scan Screen 3

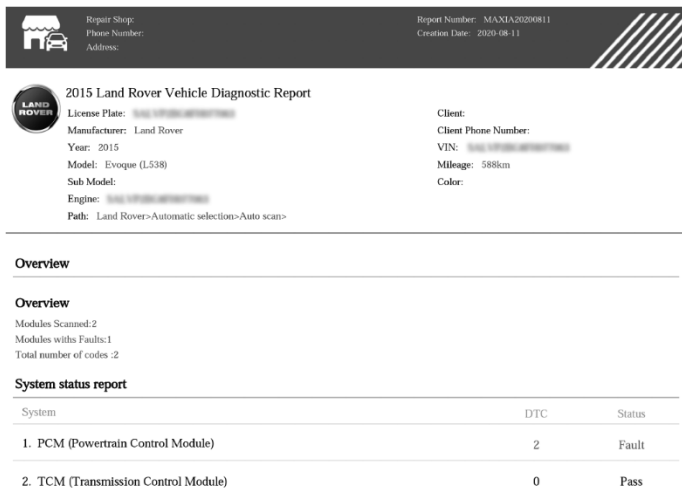

Figure 4-34 Diagnostic Report Screen

c) Via the functions on the Navigation Bar:

- The diagnostics report can also be viewed from such diagnostics function screens including Auto Scan, Read Codes, Live Data, and Active Test screens. Tap the  button in the Diagnostics Toolbar, and select **Save All Data** to save a PDF document or select **Save This Page** to save a screenshot of the current page.



Figure 4-35 Read Codes Screen

Exit Diagnostics

The Diagnostics application operates while the communication between the tablet and the vehicle is still active. It is important to properly exit from the diagnostics operation interface to stop all communications with the vehicle before closing the Diagnostics application.

NOTE

Damage to the vehicle electronic control module (ECM) may occur if communication is disrupted. Ensure all forms of communication links such as data cable, USB cable, and wireless or wired network, are properly connected throughout the test. Exit all interfaces before disconnecting the test cable and power supply.

➤ **To exit the Diagnostics application**

1. On an active diagnostic screen, tap the **Back** or **ESC** button to exit a diagnostic session, or tap the **Vehicle Swap** button in the diagnostics toolbar to return to the Vehicle Menu screen.
2. On the Vehicle Menu screen, tap the **Home** button in the top toolbar; tap the **Back** button in the navigation bar at the bottom of the screen; tap the **Home** button in the diagnostics toolbar to exit the application directly and return to the MaxiSys Job Menu.

Now, the Diagnostics application is no longer communicating with the vehicle and it is safe to open other MaxiSys applications or exit the MaxiSys Diagnostics System and return to the MaxiSys Job Menu.

5. Intelligent Diagnostics

Intelligent Diagnostics is a specific fault code analysis function, with which you can access the most comprehensive and the latest code-specific data, DTC analysis, repair assist, repair tips, and relevant repair cases. It has been drawn from real world shop repair orders and records and with input from experienced industry professionals.

Intelligent Diagnostics adopts the scientific data cloud computing technology to match the specific fault code with the exact vehicle model. And the data has been thoroughly verified by automotive maintenance professionals.

The following are main parts of the code data contained in Intelligent Diagnostics:

1. Vehicle System and Detected DTC(s)
2. Technical Service Bulletin (OEM Information)
3. DTC Analysis
4. Repair Assist
5. Repair Tips
6. Component Measurement
7. Relevant Cases

NOTE

Before performing the Intelligent Diagnostics function, please ensure the network is connected successfully.

Accessing Intelligent Diagnostics Function

Auto Scan

Before starting Intelligent Diagnostics, please ensure that vehicle communication has been established. Connect the MaxiSys Elite II tablet to the test vehicle through the VCI device. For detailed directions to establish vehicle communication with the MaxiSys tablet, see [Establish Vehicle Communication](#).

Once communication has been established, enter the **Diagnostics** application and select the vehicle model. After a vehicle model is selected, tap **Auto Scan** from the **Main menu**. The **System list** screen will display. For detailed instructions on using the Auto scan function, see [Auto Scan](#).

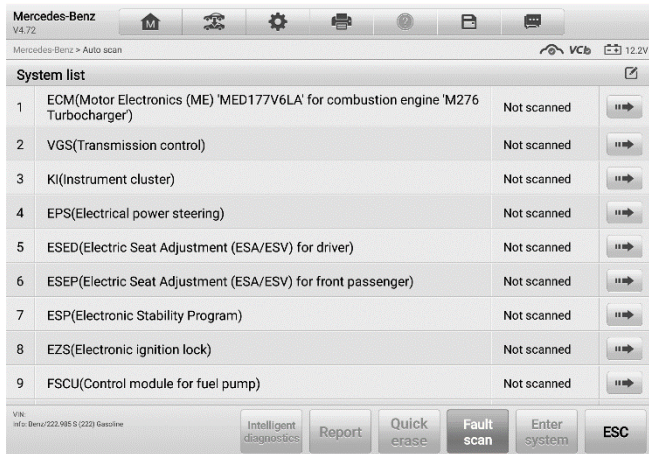

Figure 5-1 System List Screen



Scan System Faults

Tap the **Fault scan** button at the bottom to scan faults. After scanning, a system with identified faults will display in red, with the number of faults displayed on the right. The number of total faults will display on the top.



Figure 5-2 Fault Scan on System List Screen 2

After scanning system faults, there are two methods to access the Intelligent Diagnostics screen:

- Access via the **Intelligent Diagnostics** button () to view code-related information of all DTCs for the whole vehicle.
- Access via the **Intelligent Diagnostics** icon () to view code-related information

of a specific DTC.

Access via Intelligent Diagnostics Button

After all the faults of the vehicle systems are scanned, tap the **Intelligent Diagnostics** button on the lower corner of the screen to directly enter the Intelligent Diagnostics screen.

Entering the Intelligent Diagnostics screen, you can find the TSB, DTC analysis, repair assist and repair tips information of All DTCs for all the systems that have been scanned. For detailed operation instructions, please refer to the [Intelligent Diagnostics Operation](#) for details.

Access via Intelligent Diagnostics Icon

You can also use the **Intelligent Diagnostics** icon to enter the Intelligent Diagnostics function to get detailed fault repair instructions of **a specific DTC**.

The details of the detected fault(s), including the fault code, fault description and status, will be displayed right under the system name or module. If the Intelligent Diagnostics function is available for this vehicle, the **Intelligent Diagnostics** icon will display on the right.

Tap the **Intelligent Diagnostics** icon on the right side to directly enter the Intelligent Diagnostics screen.

When entering a specific system by tapping the arrow-shaped icon , you can also access the Intelligent Diagnostic screen if the Intelligent Diagnostics function is available for this vehicle.

➤ To access the Intelligent Diagnostics screen after entering a specific system

1. On the System list screen, tap the arrow icon  to enter a system, the Function menu will display. Available functions vary by vehicle.
2. Select **Trouble codes** from the Function menu screen and the trouble codes screen will display.

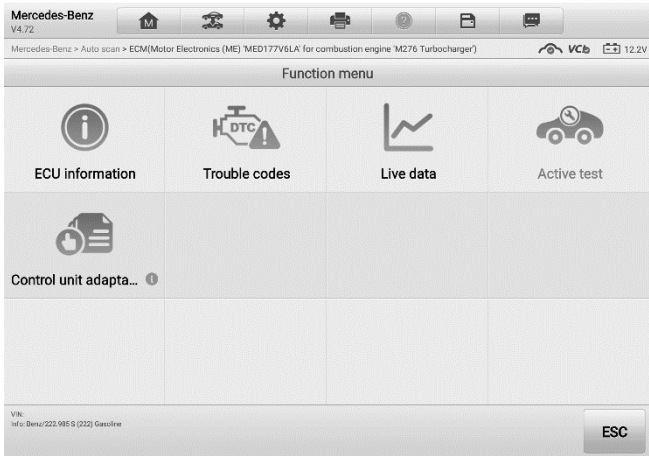



Figure 5-3 Function Menu Screen

3. Tap the **Intelligent Diagnostics** icon  to the right of the DTC description. Or select a specific DTC from the DTC list, and then tap the **Intelligent Diagnostics** button at the bottom of the screen.

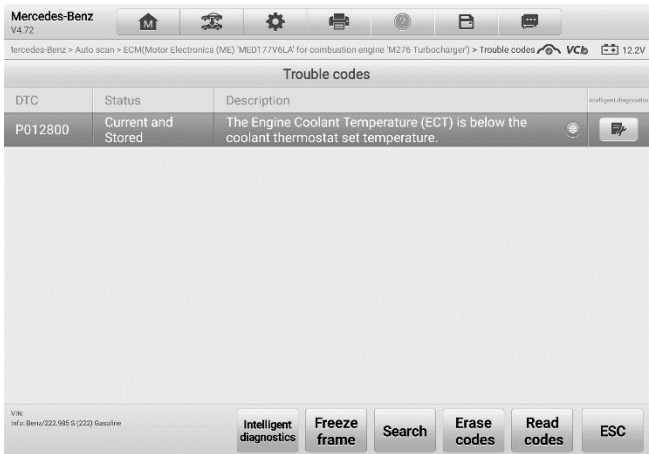

Figure 5-4 Trouble Codes Screen

Intelligent Diagnostics Operation

Intelligent Diagnostics is an important and powerful function of MaxiSys Elite II. It provides substantial information for intelligent diagnosis of the faults detected, offering Technical Service Bulletin, DTC analysis, Repair Assist, Repair tips, and Component Measurement to help you repair detected faults. It also provides relevant case information for viewing.

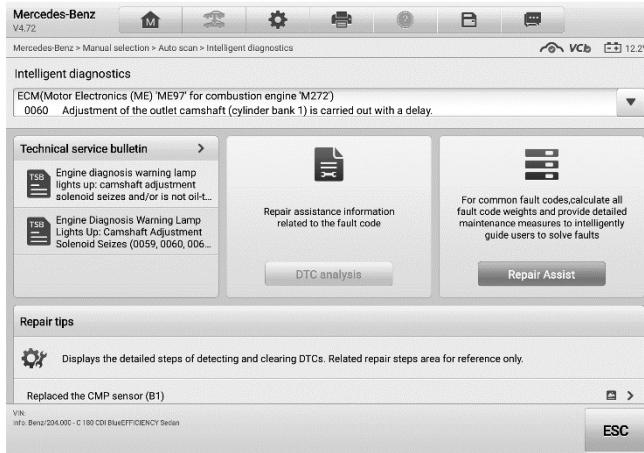

Figure 5-5 Intelligent Diagnostics Layout 1



Figure 5-6 Intelligent Diagnostics Layout 2

The **Intelligent Diagnostics** consists of the following sections:

1. **Vehicle System and Detected DTC(s)** – displays the name of the vehicle system(s) and the detected DTC(s)
2. **Technical Service Bulletin** – contains DTC-related recalls, TSB, and OEM campaigns.
3. **DTC Analysis** – provides repair assistance information related to the fault code.
4. **Repair Assist** – intelligently prioritizes DTCs and leads the user to the proper repair.
5. **Component Measurement** – provides detailed information and instructional guides on using the oscilloscope to test components for faults.
6. **Relevant Cases** – offers relevant fault-clearing cases for reference.

Vehicle System and Detected DTC(s)

This section displays the scanned vehicle systems that contain faults. Tap the drop-down menu to view comprehensive information of all systems or switch to different fault codes for details.

Tap the arrow button on the right to display a drop-down list of all systems along with specific DTCs. Use your finger to touch and slide upward or downward on the screen to review all codes in the list. Select all systems or select a DTC to view the corresponding Intelligent Diagnostics information.

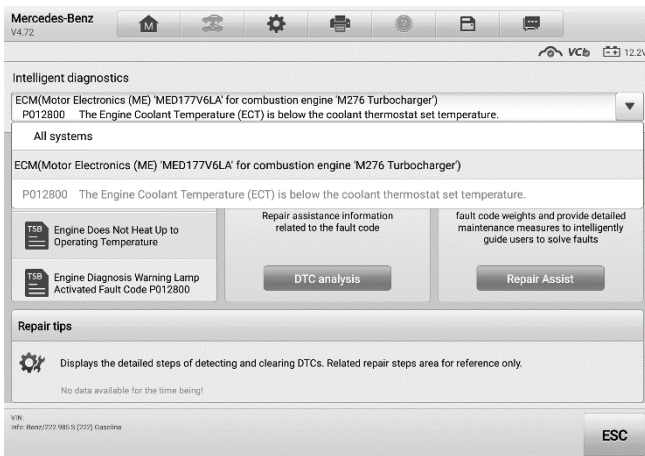

Figure 5-7 Vehicle System and Detected DTC(s) Screen

Technical Service Bulletin (OEM Information)

The Technical Service Bulletin function matches the selected fault code with relevant vehicle manufacturer TSBs. All TSBs that relate to the selected DTC are listed in the TSB display window. Select a TSB to open the TSB page and view the TSB in details.

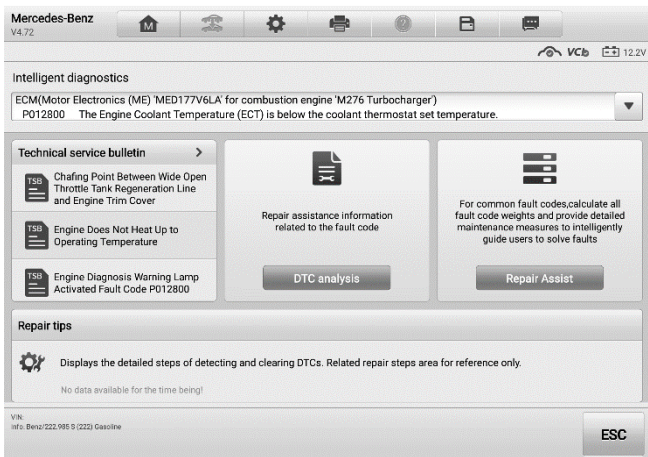

Figure 5-8 TSB Screen

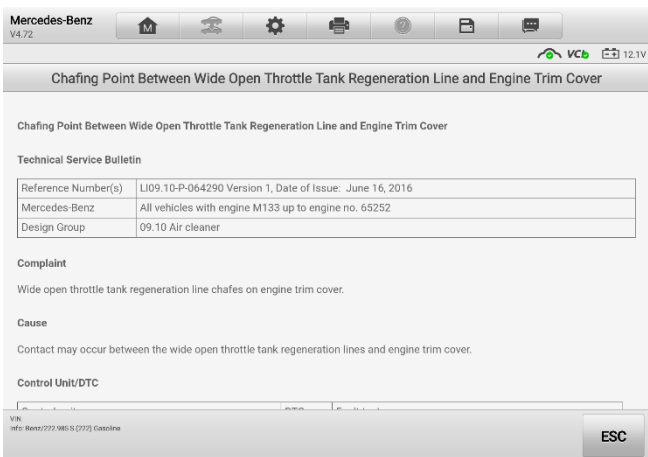

Figure 5-9 TSB in Details

DTC Analysis

On the Intelligent Diagnose screen, the DTC Analysis contains repair assistance information related to the fault codes, including the fault description, condition, fault influence, possible cause, and possible solution. The repair assistance information may vary by vehicle.

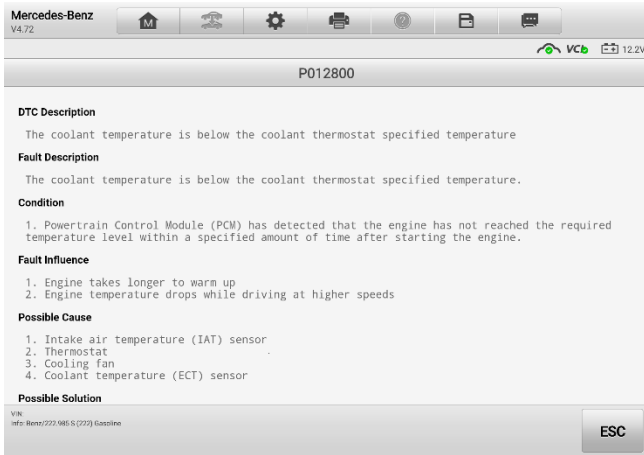

Figure 5-10 DTC Analysis Screen

Repair Assist

The Repair Assist displays a list of items and their descriptions, completion status, and priorities. The higher the priority number is (1 is the highest), the earlier the related items should be tested.

➤ **To perform Repair Assist**

1. Tap **Repair Assist** button on the Intelligent Diagnostics screen to open the page.

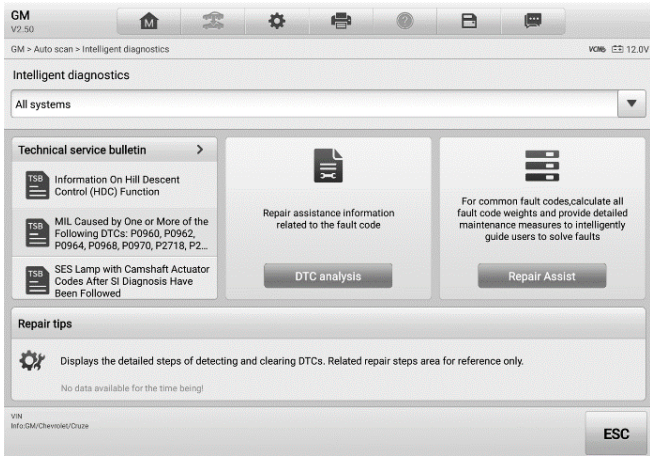



Figure 5-11 Repair Assist Screen 1

2. Tap the **Run icon**  on the right to perform the selected item. Simply follow the screen prompts and make a series of choices.

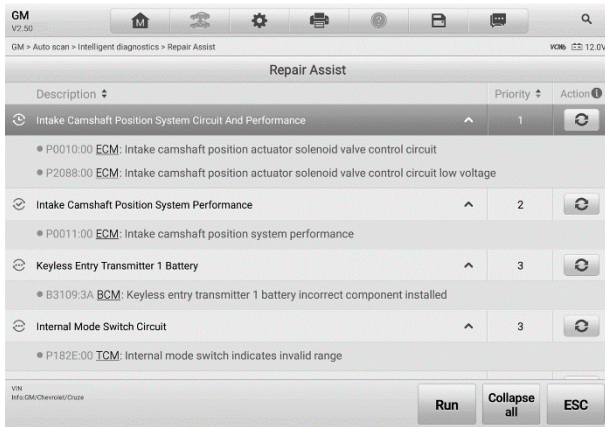





Figure 5-12 Repair Assist Screen 2

Table 5-1 Completion Status in Repair Assist

Status	Icon	Description
Completed		This indicates that all branches of the procedure are completed.
Uncompleted		This indicates that certain branches of the procedure is uncompleted.
Not running		This indicates that no branch of the procedure has run.

3. Tap the **Continue** button to go to the next step. Please note that when there are more than one DTCs in Select Branch, the ones that have run would be highlighted in blue.

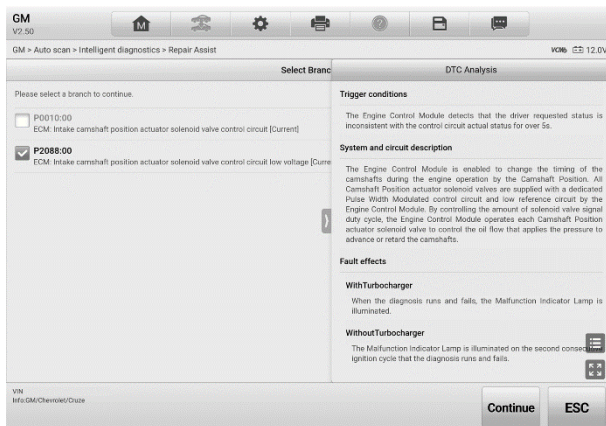

Figure 5-13 Repair Assist Screen 3

 **NOTE**

In some cases, you need to tap this icon  to fold the right column so that the whole interface of Select Branch can be shown.

4. In this repair process, it may integrate one or more diagnostic functions such as Read Codes, Erase Codes, Live Data, Freeze Frame and Active Test as needed.

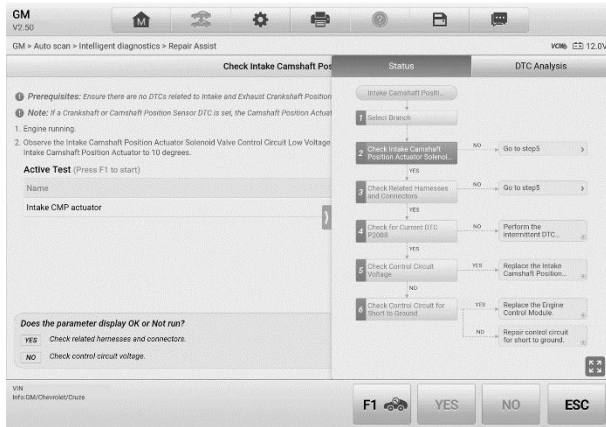

Figure 5-14 Repair Assist Screen 4



5. In some cases, it is necessary to check the circuits. Tap the first **Link icon**  to open the *Location Diagram*, and it will show the location of the component *Intake Camshaft Position Actuator Solenoid Valve* in the car.



Figure 5-15 Repair Assist Screen 5

6. Tap the second **Link icon**  to open the *Wiring Diagram* to locate the related wirings. Tap the legend button  in the upper right corner, and you will be able to locate the components, connectors, wiring, and ground electrodes by tapping the names in the list when necessary.

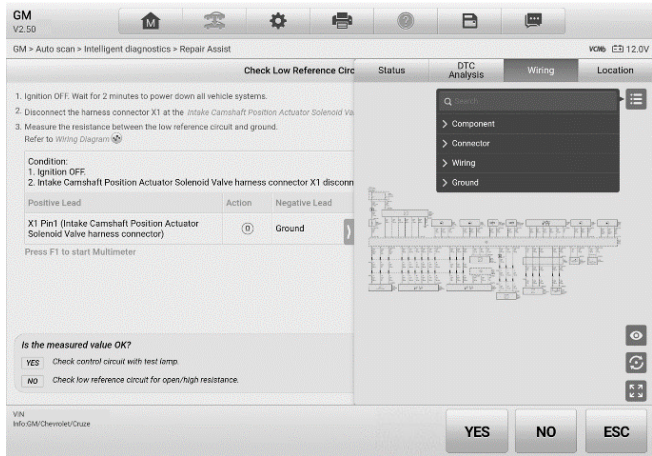

Figure 5-16 Repair Assist Screen 6

7. If you want to view details of the connector, tap the **Link icon** before the names in the list, then you will see the picture.

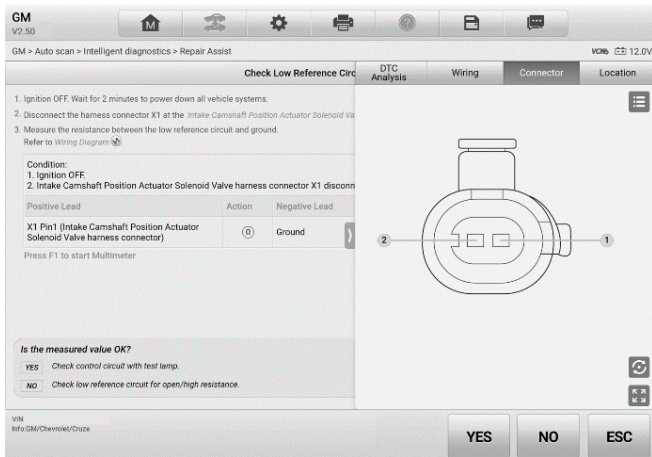

Figure 5-17 Repair Assist Screen 7

8. A solution will be generated to guide you to solve the problem with some reference information.

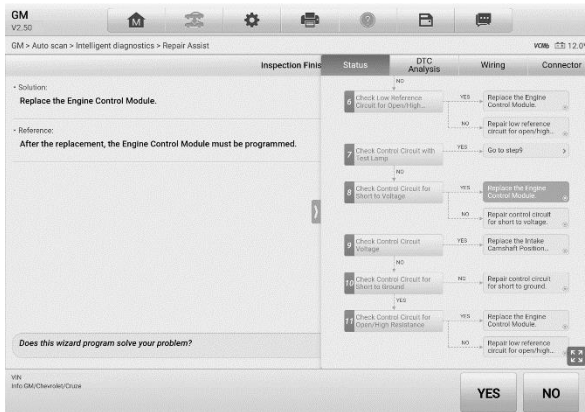

Figure 5-18 Repair Assist Screen 8

Operation instructions of the *Wiring Diagram* are as follows:

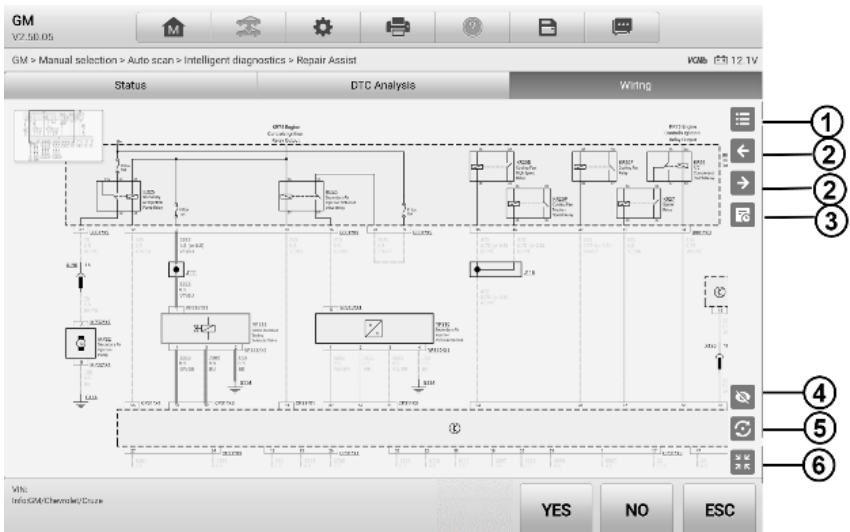











Figure 5-19 Repair Assist Screen 9

1. Tap this button  to search or tap a certain module name to locate it. After location, the related wires will be highlighted. Also, you can directly tap a certain module in the diagram to highlight it and the related wires.
2. Tap this button  to switch to the last one or tap this button  to switch to the next one.
3. Tap this button  to find what you have previously viewed.
4. Tap this button  to hide the unrelated wires, and tap this button  to show the

hidden wires.

5. Tap this button  to restore the initial settings.
6. Tap this button  to exit the full screen, and tap this button  to enter the full screen.

Repair Tips

The Repair Tips function displays a range of diagnostic and repair steps, including the information needed in order to clear the faults. The repair steps are provided in text and video.

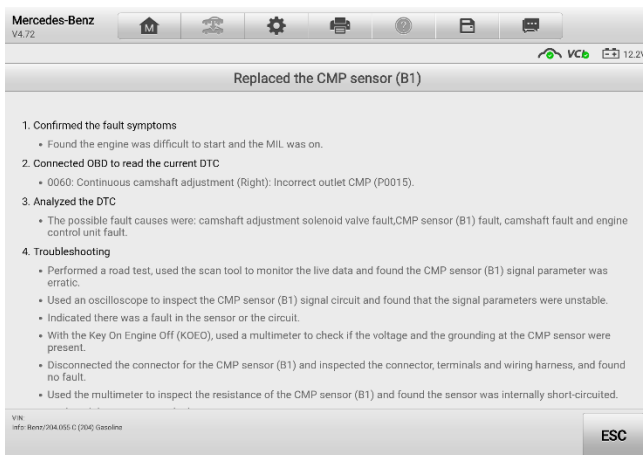

Figure 5-20 Repair Tips Description

Relevant Cases

This section offers recommended repair cases that may be relevant to the current vehicle and/or the current fault. These repair cases may provide greater insight into diagnosing and repairing your vehicle. Tap the relevant cases to review.



Figure 5-21 Relevant Case Screen

- **To review relevant cases information**
 1. Tap the **Relevant Cases** icon to display main page.
 2. Scroll through the page and to locate relevant information.
 3. Tap the arrow icon at the left top and return to the previous repair case page.

6. Service

The **Service** section is specially designed to provide quick access to the vehicle systems for various scheduled service and maintenance tasks. The typical service operation screen is a series of menu-driven commands. Follow the on-screen instructions to select appropriate options, enter values or data, and perform necessary actions. The application will display detailed instructions to complete selected service operations.

After entering each special function, the screen will display two application choices: **Diagnosis** and **Hot Functions**. The **Diagnosis** enables the reading and clearing of codes, which is sometimes necessary after completing certain special functions. **Hot Functions** consists of sub functions of the selected special function.

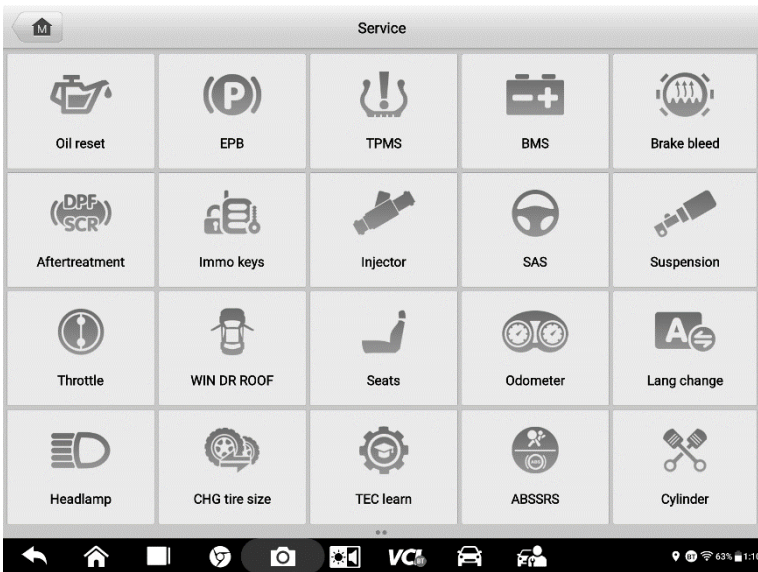

Figure 6-1 Service Menu

Several most commonly used services are described in this chapter.

Oil Reset Service

Perform reset for the Engine Oil Life system, which calculates an optimal oil life change interval depending on the vehicle driving conditions and climate. The Oil Life Reminder must be reset each time the oil is changed, so the system can calculate when the next oil change is required.

NOTE

- Always reset the engine oil life to 100% after every oil change.
 - All required work must be carried out before the service indicators are reset. Failure to do so may result in incorrect service values and cause DTCs to be stored by the relevant control module.
 - For some vehicles, the scan tool can reset additional service lights such as maintenance cycle and service interval. On BMW vehicles for example, service resets include engine oil, spark plugs, front/rear brakes, coolant, particle filter, brake fluid, micro filter, vehicle inspection, exhaust emission inspection and vehicle checks.
-

Electric Parking Brake (EPB) Service

This function has a multitude of usages to maintain the electronic braking system safely and effectively. The applications include deactivating and activating the brake control system, assisting with brake fluid control, opening and closing brake pads, and setting brakes after disc or pad replacement.

EPB Safety

It can be dangerous to perform Electric Parking Brake (EPB) system maintenance, so before you begin the service work, please keep these rules in mind.

- ✓ Ensure that you are fully familiar with the braking system and its operation before commencing any work.
 - ✓ The EPB control system may be required to be deactivated before carrying out any maintenance/diagnostic work on the brake system. This can be done from the tool menu.
 - ✓ Only perform maintenance work when the vehicle is stationary and on level ground.
 - ✓ Ensure that the EPB control system is reactivated after the maintenance work has been completed.
-

NOTE

Autel accepts no responsibility for any accident or injury arising from the maintenance of the Electric Parking Brake system.

Tire Pressure Monitoring System (TPMS) Service

This function allows you to quickly look up the tire sensor IDs from the vehicle ECU, as well as to perform TPMS replacement and reset procedures after tire sensors are replaced.

Battery Management System (BMS) Service

The Battery Management System (BMS) allows the tool to evaluate the battery charge state, monitor the close-circuit current, register the battery replacement, activate the rest state of the vehicle, and charge the battery via the diagnostic socket.

NOTE

- This function is not supported by all vehicles.
- The sub functions and actual test screens of the BMS may vary by vehicle, please follow the on-screen instructions to make correct option selection.

The vehicle may use either a sealed lead-acid battery or an Absorbed Glass Mat (AGM) battery. Lead acid battery contains liquid sulphuric acid and can spill when overturned. AGM battery (known as VRLA battery, valve regulated lead acid) also contains sulphuric acid, but the acid is contained in glass mats between terminal plates.

It is recommended that the replacement aftermarket battery has the same specifications, such as capacity and type, as the exiting battery. If the original battery is replaced with a different type of battery (e.g. a lead-acid battery is replaced with an AGM battery) or a battery with a different capacity (mAh), the vehicle may require reprogramming of the new battery type, in addition to, performing the battery reset. Consult the vehicle manual for additional vehicle-specific information.

Diesel Particle Filter (DPF) Service

The Diesel Particle Filter (DPF) function manages DPF regeneration, DPF component replacement teach-in and DPF teach-in after replacing the engine control unit.

The ECM monitors driving style and selects a suitable time to employ regeneration. Cars driven a lot at idling speed and low load will attempt to regenerate earlier than cars driven more with higher load and speed. For regeneration to take place, a prolonged high exhaust temperature must be obtained.

In the event of the car being driven in such a way that regeneration is not possible, i.e., frequent short journeys, a diagnostic trouble code will eventually be registered in addition to the DPF light and “Check Engine” indicators displaying. A service regeneration can be requested in the workshop using the diagnostic tool.

Before performing a forced DPF regeneration using the tool, check the following items:

- The fuel light is not on.
- No DPF-relevant faults are stored in system.
- The vehicle has the specified engine oil.
- The oil for diesel is not contaminated.

! IMPORTANT

Before diagnosing the problem vehicle and attempting to perform an emergency regeneration, it is important to obtain a full diagnostic log and read out relevant measured value blocks.

🔧 NOTE

- The DPF will not regenerate if the engine management light is on, or there is a faulty EGR valve.
 - The ECU must be re-adapted when replacing the DPF and when topping up the fuel additive Eolys.
 - If the vehicle needs to be driven in order to perform a DPF service, a second person is needed for the function. One person should drive the vehicle while the other person observes the screen on the Tool. Do not attempt to drive and observe the scan tool at the same time. This is dangerous and puts your life and the lives of other motorists and pedestrians at risk.
-

Immobilizer (IMMO) Service

An immobilizer is an anti-theft mechanism that prevents an automobile's engine from starting unless the correct ignition key or other device is present. This device prevents thieves from starting the car by a method known as hot wiring. Most new vehicles have an immobilizer as standard equipment. An important advantage of this system is that it doesn't require the car owner to activate it; it operates automatically. An immobilizer is considered as providing much more effective anti-theft protection than an audible alarm alone; many auto insurance companies offer lower rates for vehicles that are equipped with an immobilizer.

As an anti-theft device, an immobilizer disables one of the systems needed to start a car's engine, usually the fuel supply or the ignition. This is accomplished by radio frequency identification between a transponder in the ignition key and a device called a radio frequency reader in the steering column. When the key is placed in the ignition, the transponder sends a signal with a unique identification code to the reader, which relays it to a receiver in the vehicle computer control module. If the code is correct, the computer allows the fuel supply and ignition systems to operate and start the car. If the code is incorrect or absent, the computer disables the system, and the car will be unable to start until the correct key is placed in the ignition.

The IMMO service can disable a lost vehicle key and program the replacement key fob. One or more replacement key fobs can be programmed.

Steering Angle Sensor (SAS) Service

SAS Calibration permanently stores the current steering wheel position as the straight-ahead position in the SAS EEPROM. Therefore, the front wheels and the steering wheel must be set exactly to the straight-ahead position before calibration. In addition, the VIN is also read from the instrument cluster and stored permanently in the SAS EEPROM. On successful completion of calibration, the SAS fault memory is automatically cleared.

Calibration must always be carried out after the following operations:

- Steering wheel replacement
- SAS replacement
- Any maintenance that involves opening the connector hub from the SAS to the column
- Any maintenance or repair work on the steering linkage, steering gear or other related mechanism
- Wheel alignment or wheel track adjustment
- Accident repairs where damage to the SAS or assembly, or any part of the steering system may have occurred

NOTE

- Autel accepts no responsibility for any accident or injury arising from servicing the SAS system. When interpreting DTCs retrieved from the vehicle, always follow the manufacturer's recommendation for repair.
 - All software screens shown in this manual are examples, and actual test screens may vary by test vehicle. Pay attention to the menu titles and onscreen instructions to make correct option selections.
 - Before starting procedure, make sure the vehicle has an **ESC** button. Look for button on dash.
-

7. ADAS

Advanced Driver Assistance Systems (ADAS) is an array of vehicle systems that aid the driver either through passive alerts or by active control of the vehicle to drive safer and with greater awareness and precision.

Cameras, sensors, ultrasound, radar and LIDAR are some of the systems used to capture the driving environment data, including travelling or static vehicles position, pedestrian location, road sign, driving lane and intersection detection, road (curves) and driving conditions (poor visibility or evening driving). Use that information to instruct the vehicle to take its predetermined action. Cameras, sensors and sensing systems are typically located in front and rear bumpers, windshield, front grill, and side and rear view mirrors.

Autel ADAS Calibration Tool provides comprehensive and precise ADAS calibration.

1. Covers many vehicle makes, including Benz, BMW, Audi, Volkswagen, Porsche, Infiniti, Lexus, GM, Ford, Volvo, Toyota, Nissan, Honda, Hyundai, and Kia.
2. Supports the calibration of multiple driver assistant systems, including Adaptive Cruise Control (ACC), Night Vision System (NVS), Lane Departure Warning (LDW), Blind Spot Detection (BSD), Around View Monitoring (AVM), Rear Collision Warning (RCW) and Heads-up Displays (HUD).
3. Provides graphic illustrations and step-by-step instructions.
4. Provides demos to guide the technician through the calibration.



Figure 7-1 Autel ADAS Introduction Screen

8. Data Manager

The Data Manager application allows you to store, print, and review the saved files, manage the workshop information, customer information records and keep test vehicle records.

Tap the **Data Manager** application to open the file system menu. There are eight functions available.

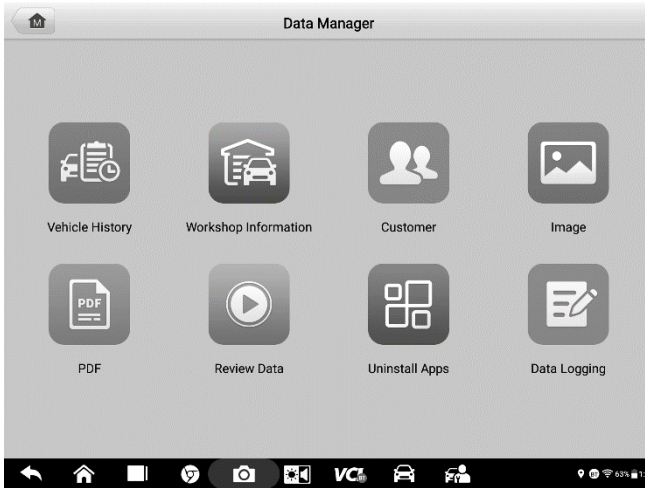





Figure 8-1 Data Manager Main Screen

The table below describes each of the function buttons in the Data Manager application.

Table 8-1 Buttons in Data Manager

Name	Button	Description
Vehicle History		Tap to view the diagnostic records.
Workshop Information		Tap to view or edit the workshop information.
Customer		Tap to create a new customer account file.
Image		Tap to view the screenshots.
PDF		Tap to view the diagnostic reports.

Name	Button	Description
Review Data		Tap to view the recorded data.
Uninstall Apps		Tap to uninstall applications.
Data Logging		Tap to view communications with Autel support service and ECU information of the test vehicle. The saved data can be reported and sent to the technical center via the Internet.

Vehicle History

This function stores records of test vehicle history, including vehicle information and the retrieved DTCs from previous diagnostic sessions. Test information is summarized and displayed in an easy-to-read table listing. The Vehicle History also provides direct access to the previously tested vehicle and allows you to directly restart a diagnostic session without needing to perform auto or manual vehicle selection.

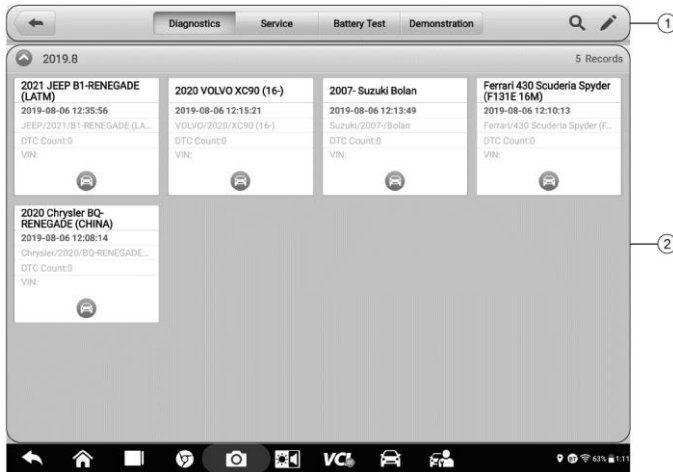

Figure 8-2 Vehicle History Screen

1. Top Toolbar Buttons — navigation and application controls.
2. Main section — displays all the vehicle records.

➤ **To activate a test session for the recorded vehicle**

1. Tap **Data Manager** on the MaxiSys Job Menu.

2. Select **Vehicle History** to open the screen. Tap **Diagnostics** or **Service** to select diagnostic test records or service test records.
3. Tap **Diagnostics** icon at the bottom of the thumbnail of a vehicle record item.
4. The Diagnostics screen of the vehicle displays and a new diagnostics session is activated (See [Diagnostics](#) for detailed instructions on vehicle diagnostics operations), or select a vehicle thumbnail to select a record. A Test Records window appears. Review the recorded information of the test vehicle, and tap the **Diagnostics** button on the upper-right corner to continue diagnostics.

Test Records

A Test Record is a detailed data form of the tested vehicle, which includes general vehicle information, service record, customer information, and the diagnostic trouble codes retrieved from previous test sessions. Technician Notes will also display if present.

NOTE

The MaxiSys tablet must establish a connection to the VCI to restart test sessions on a previously tested vehicle.

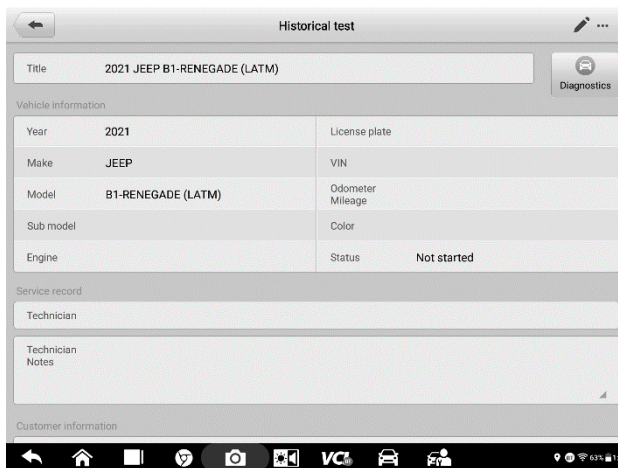

Historical test		
Title		2021 JEEP B1-RENEGADE (LATM)
Vehicle Information		
Year	2021	License plate
Make	JEEP	VIN
Model	B1-RENEGADE (LATM)	Odometer Mileage
Sub model		Color
Engine		Status Not started
Service record		
Technician		
Technician Notes		
Customer information		

Figure 8-3 Test Records Sheet

➤ To edit the Test Records

1. Tap **Data Manager** in the MaxiSys main screen.
2. Select **Vehicle History**.
3. Select the specific vehicle history record thumbnail from the main section. The test record will display.
4. Tap the **Edit** button (the pen icon) to start editing.
5. Tap each item to enter information or attach files or images.

6. Tap **Add a Customer** to associate the test record sheet to an existing customer account, or add a new account to be associated with the test vehicle record. See [Customer](#) for more information.
7. Tap **Done** to save the updated record, or tap **Cancel** to exit without saving.

NOTE

The vehicle VIN, license number and customer account are associated by default. Vehicle records will automatically be associated using this vehicle and customer identification.

Workshop Information

Workshop Information allows you to enter, edit, and save detailed workshop information, such as shop name, address, phone number and other remarks, which, when printing vehicle diagnostic reports and other associated test files, will appear as the header of your printed documents.

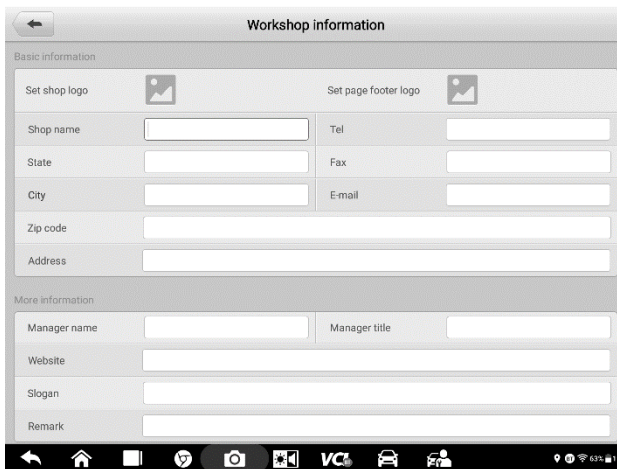

Figure 8-4 Workshop Information Sheet

➤ To edit the Workshop information sheet

1. Tap **Data Manager** on the MaxiSys Main Screen.
2. Select **Workshop Information**.
3. Tap on each field to enter the corresponding information.
4. Tap **Done** to save the updated workshop information, or tap **Cancel** to exit without saving.

Customer

The Customer function allows you to create and edit customer accounts. It helps you to save and organize all customer accounts associated with the test vehicle records.

➤ **To create a customer account**

1. Tap the **Data Manager** application on the MaxiSys main screen.
2. Select **Customer**.
3. Tap the **Add a customer** button. A blank information form appears. Tap each field to enter the appropriate information.

 **NOTE**

Required fields are denoted by an asterisk.

4. For customers with more than one vehicle for service, tap **Add New Vehicle Information**. To delete the added vehicle information, tap the  button.
5. Tap **OK** on the upper-right corner of the screen to save the customer information, or tap **Cancel** to exit without saving.

➤ **To edit a customer account**

1. Tap **Data Manager** on the MaxiSys Job Menu.
2. Select **Customer**.
3. Select a customer account by tapping the corresponding name card. The Customer Information record displays.
4. Tap **Edit** on the top toolbar to start editing.
5. Tap on the input field to edit the information.
6. Tap **Complete** to save the updated information, or tap **Cancel** to exit without saving.

➤ **To delete a customer account**

1. Tap **Data Manager** on the MaxiSys Job Menu.
2. Select **Customer**.
3. Select a customer account by tapping the corresponding name card. The Customer Information record appears.
4. Tap **Edit** on the top toolbar to start editing.
5. Tap **Delete** button on the top of the screen. A reminder message appears.
6. Tap **OK** to confirm the command, and delete the account. Tap **Cancel** to cancel the request.

Image







The Image section is a database containing all captured screenshots.

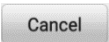

Figure 8-5 Image Database Screen

1. **Toolbar Buttons** — edits, prints or deletes the image files. See [Table 8-2 Toolbar Buttons Description](#) for detailed information.
2. **Main Section** — displays the stored images.

Table 8-2 Toolbar Buttons Description

Name	Button	Description
Back		Return to the previous screen.
Search		Tap to enter the search page.
Edit		Tap to display the editing toolbar to print, delete or view image.
Cancel		Tap to close the editing toolbar or cancel file search.
Search		Quickly searches the image by entering the time of the screenshot.
Print		Tap to print the selected image.
Delete		Tap to delete the selected image.
Email		Tap to attach the selected image to an email.

➤ **To edit/delete image(s)**

1. Select **Data Manager** from the MaxiSys Job Menu.
2. Select **Image** to access the image database.
3. Tap **Edit** on the top-right corner of the window. The editing screen appears.
4. Select the image(s) you want to edit by tapping the check box at the bottom-right corner of the image.
5. Tap **Delete** to delete the selected images or delete all images. Tap **Print** icon to print the selected image(s). Tap **Email** to attach the selected image(s) to an email.

PDF Files

The PDF section stores and displays all PDF files of saved data. After entering the PDF database, select a PDF file to view the stored information.

This section uses the standard Adobe Acrobat Reader application for file viewing and editing. Please refer to the Adobe Acrobat Reader manual for more detailed instructions.

Review Data

The Review Data function allows you to play back the recorded data frames from live data streams.

On the Review Data main screen, select a record to play back.

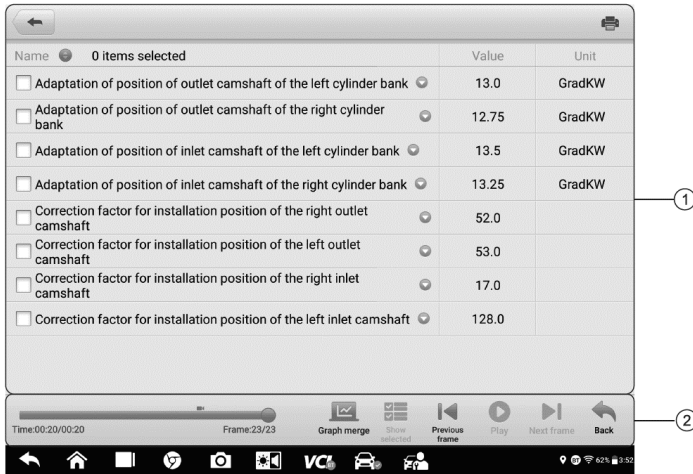

Figure 8-6 Data Playback Screen

1. Main Section — displays the recorded data frames.
2. Navigation Toolbar — allows you to operate data playback.

Use the Navigation Toolbar buttons to play back the record data from frame to frame.

Tap **Back** to exit data playback.

Uninstall Apps

This section allows you to manage the software application installed on the MaxiSys Diagnostics System. Selecting this section opens a management screen, on which you can check all the available vehicle diagnostics applications.

Select the vehicle software you want to delete by tapping on the car brand icon. The selected item will display a blue check mark on the upper-right corner. Tap the **Delete** button on the top bar to delete the software from the system database.

Data Logging

The Data Logging section allows you to launch the Support platform to view all records with or without feedback (saved) data logs on the diagnostics system. For more information, please refer to [Data Logging](#).

9. Settings

Access the Settings menu to adjust default settings and view information about the MaxiSys system. The following options are available for the MaxiSys system settings:

- Unit
- Language
- Printing Settings
- Notification Center
- Auto Update
- ADAS Settings
- Vehicle List
- System Settings
- About

Unit

This option allows you to change the measurement unit for the diagnostics system.

➤ To change the unit setting

1. Tap the **Settings** application on the MaxiSys Job Menu.
2. Tap the **Unit** option on the left column.
3. Select the appropriate measurement unit, Metric or English. A check mark displays to the right of the selected unit.
4. Tap the **Home** button on the top left corner to return to the MaxiSys Job Menu, or select another setting option for the system setup.

Language

This option allows you to change the display language for the MaxiSys system.

➤ To adjust the language setting

1. Tap the **Settings** application on the MaxiSys Job Menu.
2. Tap the **Language** option on the left column.
3. Select the appropriate language. A check mark displays to the right of the selected language.
4. Tap the **Home** button on the top left corner to return to the MaxiSys Job Menu, or select another setting option for the system setup.

Printing Settings

Printing Setting

This option allows you to print from the tablet to a network printer via a computer.

➤ To set up the printer connection

1. Tap **Settings** on the MaxiSys Job Menu.
2. Tap **Printing Settings** on the left column.
3. Tap **Print via Network** to activate the printing function, which enables the device to send files to the printer through the PC via Wi-Fi or Ethernet connection.
4. Tap **Home** on the top-left corner to return to the MaxiSys Job Menu, or select another setting option for the system setup.

Printing Operations

➤ To install the MaxiSys Printer driver program

1. Download the Maxi PC Suite from www.autel.com > **Support** > **Downloads** > **Diagnostic Tool** and install to your PC.
2. Double click the **setup.exe** file.
3. Select the installation language and the wizard will load momentarily.
4. Follow the instructions on the screen and click **Next** to continue.
5. Click **Install**. The printer driver program will be installed onto the PC.
6. Click **Finish** to complete the installation.

This section describes how to receive files from the MaxiSys tablet and perform printing through the computer:

➤ To print through from a computer

1. Make sure the tablet is connected to the computer network, via Wi-Fi or LAN, before printing.
2. Run the **PC Link** program on the computer.
3. Tap **Test Print** to check whether the printer works properly.
4. Tap the **Print** button on the toolbar of the tablet. A test document will be sent to the computer.
 - If the **Auto Print** option in the MaxiSys Printer is selected, the MaxiSys printer will automatically print the received document.
 - If the **Auto Print** option in the MaxiSys Printer is not selected, tap the **Open PDF File** button to view files. Select the file(s) to be printed and tap **Print**.

NOTE

Make sure the computer installed with the Printing Services program is connected to a printer.

Notification Center

This option allows you to turn the Notification Center function on or off. The Notification Center function configures the MaxiSys tablet to receive regular online messages from the server for system update notifications or other service information via the Internet. It is highly recommended that the Notification setting be on at all times so as not to miss news of updates or important service messages. Internet access is required for receiving online messages.

➤ To enable the Notification Center function

1. Tap **Settings** on the MaxiSys Job Menu.
2. Tap **Notification Center** on the left column.
3. Tap **ON/OFF** to enable or disable the Notifications function. If the function is enabled, the button displays blue, or if disabled, the button displays gray.
4. Tap **Home** on the top-left corner to return to the MaxiSys Job Menu, or select another setting option for the system setup.

When the Notification Center function is turned on and new messages are received by the MaxiSys device, a notification message displays on the MaxiSys Job Menu. Press on the message bar and drag it down to display a list of received messages. Slide the list up or down to view additional messages if present.

Tap a specific message to launch the corresponding application. For example, if you tap on an Update notification message, the Update application will be launched.

Auto Update

This option allows you to preset a time to update the software. There are three update options: OS Update, MaxiSys Update, and Vehicle Update.

Tap **ON/OFF** to enable or disable Auto Update. The button displays blue if Auto Update is enabled and displays grey if the Auto Update is disabled. Set the time of the day for updating. If a specific time is set, the selected software will be automatically updated at this exact time.

ADAS Settings

➤ To active MaxiSys ADAS Calibration

1. Confirm that updates for the registered MaxiSys tablet are available.

2. Tap the **Settings** application on the MaxiSys Job Menu.
3. Make sure that the internet is available. Select **ADAS Settings** on the left column.
4. Scan the QR code on the ADAS frame to bind, or manually input frame serial number when QR code is not available.
5. Enter the verification code from the ADAS Calibration Card.
6. The system will reset and the main screen will display once registration has been completed.

Vehicle List

This option allows you to sort the vehicles either by alphabetic order or by frequency of use.

➤ To adjust the vehicle list setting

1. Tap the **Settings** application on the MaxiSys Job Menu.
2. Select **Vehicle list** on the left column.
3. Select the required sort type. A check mark will display on the right of the selected sort type.
4. Tap the **Home** button on the top-left corner to return to the MaxiSys Job Menu, or select another setting option for system setup.

System Settings

This function provides direct access to the Android system settings interface, where you can adjust various system settings for the Android system platform, regarding wireless and network settings, various device settings such as sound and display, as well as system security settings, and check related information about the Android system. Refer to Android documentation for additional information.

About

The About function provides information of the MaxiSys diagnostics device, including the product name, version, hardware, and serial number.

➤ To check the MaxiSys product information in About

1. Tap the **Settings** application on the MaxiSys Job Menu.
2. Select the **About** option on the left column. The product information screen displays on the right.
3. Tap the **Home** button on the top-left corner to return to the MaxiSys Job Menu, or select another setting option for the system setup after viewing.

10. Battery Test

Battery Test conducts battery and cranking/charging systems analysis and enables technicians to view the health status of the vehicle's battery and cranking/charging system. Functions include in-vehicle test and out-vehicle test.

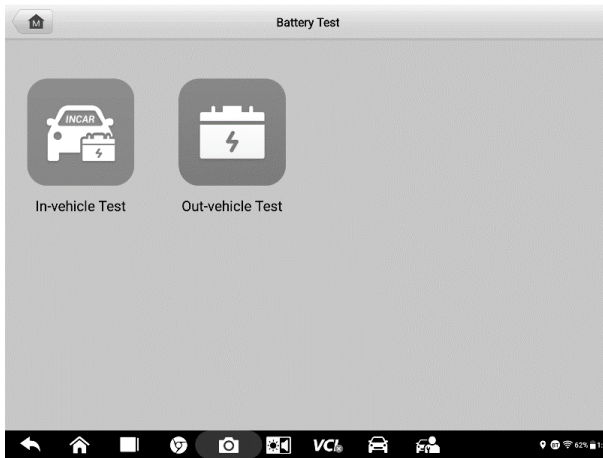

Figure 10-1 *Battery Test Screen*

Test Preparation

Inspect the Battery

Before starting a test, observe the battery for:

- Cracking, buckling or leaking (If you see any of these defects, replace the battery.)
- Corroded, loose or damaged cables and connections (Repair or replace as needed.)

Corrosion on the battery terminals, and dirt or acid on the case top (Clean the case and terminals using a wire brush and a mixture of water and baking soda.)

Connect the Battery Tester

➤ To pair the BT506 with the MaxiSys Elite II tablet

1. Press and hold the **Power** Button to turn on the MaxiSys Elite II. Ensure that the unit is sufficiently charged before using.
2. Enable **Bluetooth** on the MaxiSys Elite II by tapping **VCI Manager > BAS BT**, and the tablet automatically scans for an available tester for Bluetooth pairing.

The device name will appear as “Maxi” suffixed with the device serial number.

3. Check the serial number of your BT506 series tester and select the desired device for pairing.
4. When paired successfully, the connection status will read as “Connected” and the Status LED will flash blue.

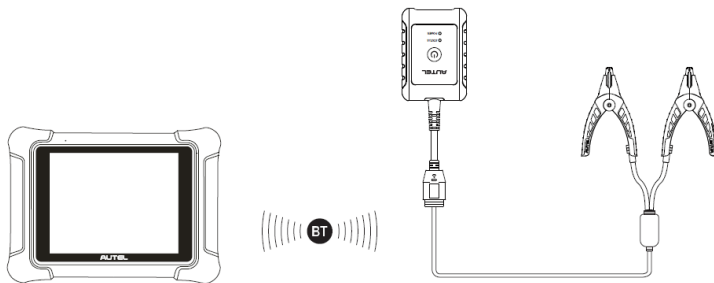

Figure 10-2 Connecting with the Tablet

➤ **To connect to a battery**

Connect the red clamp to the positive (+) terminal and the black clamp to the negative (-) terminal of the battery.

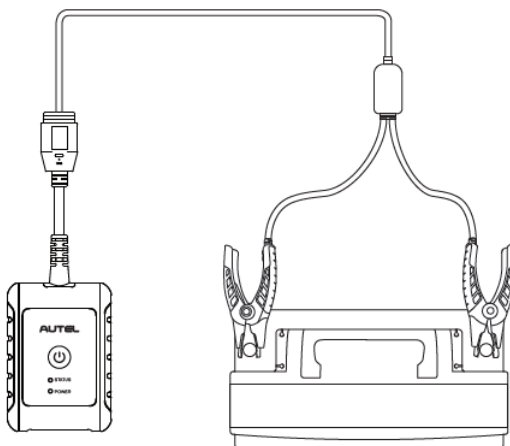

Figure 10-3 Connecting to a Battery

In-vehicle Test

In-vehicle Test is used for testing batteries that are installed in a vehicle. An in-vehicle test includes Battery Test, Starter Test, and Generator Test. These tests help determine the health status of the battery, the starter, and the generator.

! IMPORTANT

A disclaimer page will appear when accessing any function on the **Home** screen for the first time. Please read the end user agreement and Tap **Accept** to continue. If you tap **Decline**, you will not be able to use the features properly.

➤ Confirm Vehicle Information

1. Tap the **Battery Test** application and then select **In-vehicle Test**.
2. Confirm your vehicle information and make sure the VIN information is filled.
3. Confirm your battery information, including voltage, type, standard, and capacity. Tap **Next** to continue.

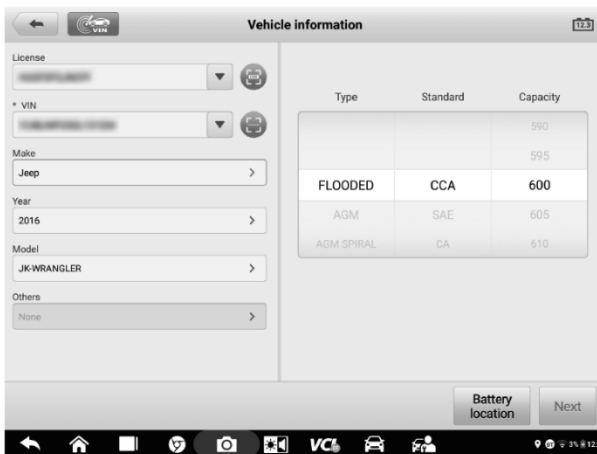







Figure 10-4 *Battery information Screen*

Please refer to the table below for a list of buttons that may appear when accessing the functions:

Table 10-1 Top Toolbar Buttons

Button	Name	Description
	Battery Connection	The value on the icon indicates the real-time voltage of the tested battery. In the battery test, the button will turn green if the battery is good; otherwise, it will turn red.
	Home	Returns to the Maxisys Job Menu.
	Next	Tap to proceed.
	Back	Returns to the previous screen.
	Exit	Returns to the Job Menu.

Battery Test

1. Follow the on-screen instructions. Check the boxes once all required tasks are completed, and tap **Start Testing**.

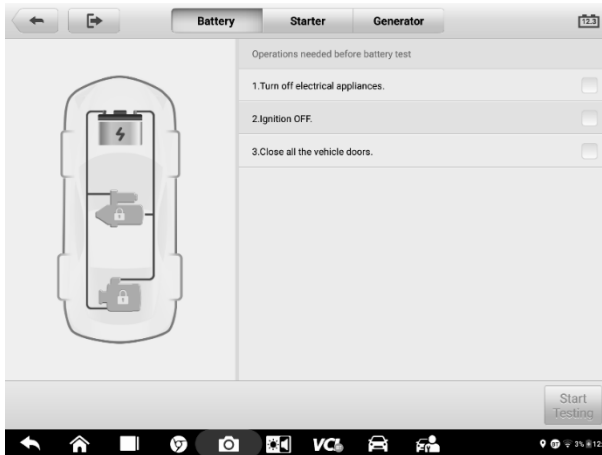

Figure 10-5 Battery Screen

- Wait until the test is completed. The test results will be displayed on the tool.



Figure 10-6 Battery Test Results Screen

Battery Test Results

The battery test results include a color-coded results summary, a list of test data, and repair tips.

Table 10-2 Test Results

Result	Repair Tip
Good Battery	Battery is good.
Good & Recharge	Battery is good but insufficiently charged. Recharge the battery.
Charge & Retest	Battery requires charge to determine its condition.
Bad Cell	Replace the battery.
Replace Battery	Replace the battery.

NOTE

Please always complete the battery test before you proceed to the starter and generator tests.

Starter Test

Follow the on-screen instructions to complete the test. Start the engine and let it idle. The test results will appear as follows:

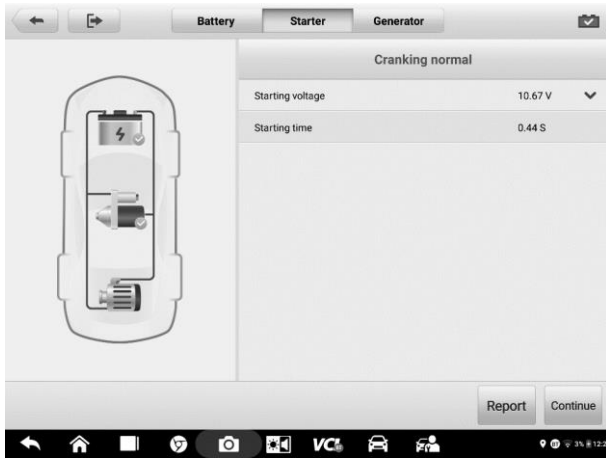

Figure 10-7 Starter Test Result Screen

Table 10-3 Starter Test Results

Result	Description
Cranking Normal	The starter is good.
Current Too Low	Low momentary discharge capacity.
Voltage Too Low	Low battery storage capacity.
Not Started	The starter is not detected for starting.

Generator Test

Follow the on-screen instructions to complete the test. The test results will appear as follows:

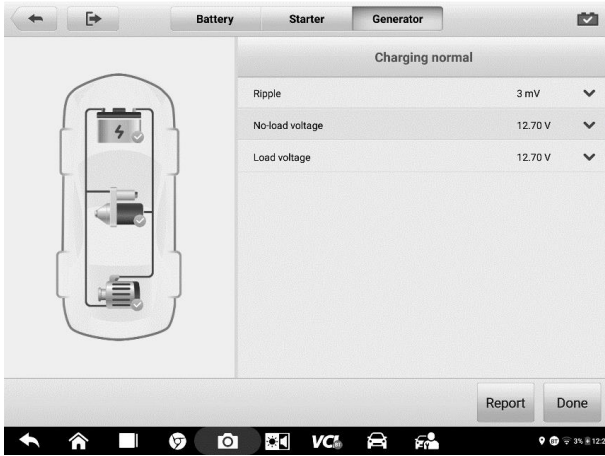

Figure 10-8 Generator Test Results Screen

Table 10-4 Generator Test Results

Result	Description
Charging Normal	The generator is functioning normally.
Output Too Low	<ul style="list-style-type: none"> ● The belt linking the starter and the generator is loose; ● The cable linking the starter and battery is loose or corroded.
Output Too High	<ul style="list-style-type: none"> ● The generator is not properly connected to the ground; ● The voltage adjuster is broken and needs replacement.
Ripple Too Large	The commutation diode is broken.
No Output	<ul style="list-style-type: none"> ● The cable is loose; ● Some vehicles with power management systems do not provide path for charging due to the sufficient load capacity of the battery; ● The generator or the voltage adjuster is broken and needs replacement.

NOTE

To measure the current, connect the current clamp. Tap the **Settings** button on the main menu to enter the application. Swipe the **Current Clamp** toggle to turn it **ON**.

Out-vehicle Test

Out-vehicle Test is used to test the conditions of batteries that are not connected to a vehicle. This function aims to check the health status of the battery only.

Test Procedure

- **To start the out-vehicle test**
 1. Tap the **Battery Test** application and then select **Out-vehicle Test**.
 2. Connect the tester clamps to the battery terminals.
 3. Select the appropriate battery type, rating standard, and CCA value. Tap **Start Testing** to start the test.

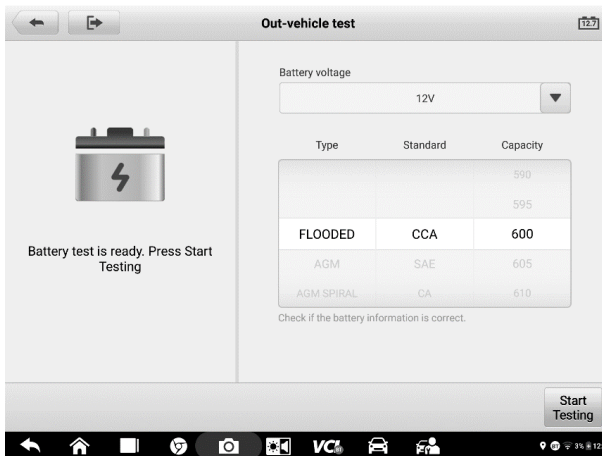

Figure 10-9 Out-vehicle Test Screen

4. The test results will display in a few seconds.



Figure 10-10 Out-vehicle Test Results Screen

Test Results

Icons are color-coded to indicate status.

Table 10-5 Out-vehicle Test Results

Result	Description
Good Battery	Battery meets required standards.
Good & Recharge	Battery is good, but low on charge. Fully charge the battery. Check for causes of low charge.
Charge & Retest	Battery requires charge to determine its condition.
Replace Battery	Battery fails to meet industry-accepted standards.
Bad Cell	Battery fails to meet industry-accepted standards.

11. VCI Manager

The VCI Manager is for connecting the MaxiSys Elite II tablet with a VCI through Bluetooth. This application allows you to pair the tablet with the VCI and to check its communication status.

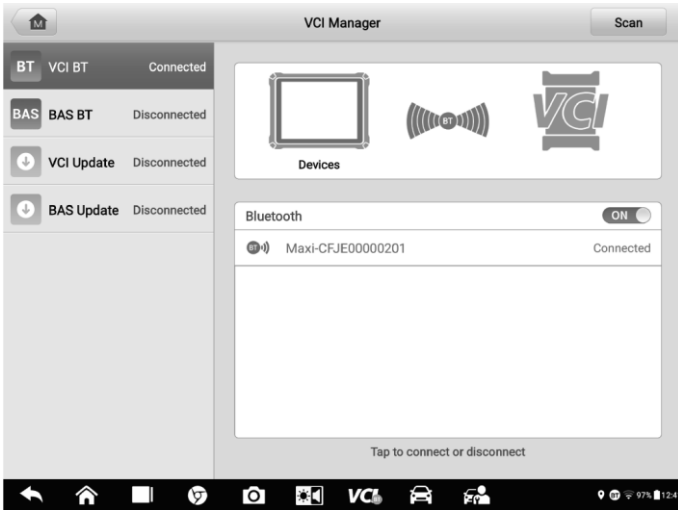

Figure 11-1 VCI Manager Screen

VCI Connection via Bluetooth

The VCI device needs to be either connected to a vehicle or to an available power source, so that it is powered up during the synchronization procedure. Make sure the tablet has a fully charged battery or is connected to an external power supply.

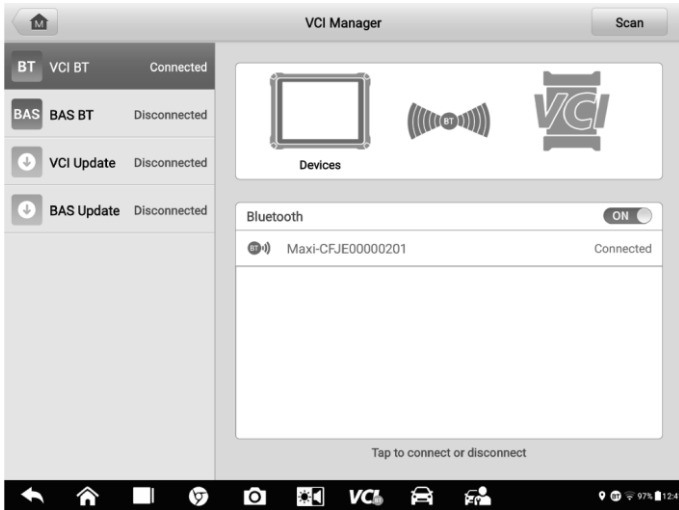

Figure 10-2 VCI Bluetooth Pairing Screen

➤ **To pair the VCI device with the tablet via Bluetooth**

1. Power on the tablet.
2. Connect the 26-pin end of the data cable to the VCI's vehicle data connector.
3. Connect the 16-pin end of the data cable to the vehicle Data Link Connector (DLC).
4. Tap **VCI Manager** on the MaxiSys Job Menu of the tablet.
5. Select **VCI BT** (short for VCI Bluetooth), from the connection mode list.
6. Toggle Bluetooth **ON**. Tap **Scan** at the top-right corner. The device will start searching for available units for pairing.
7. Depending on the VCI you use, the device name may appear as “Maxi” suffixed with the serial number. Select the appropriate device for pairing.
8. When paired successfully, the connection status reads as “Connected”.

9. After a few seconds, the VCI button on the system Navigation Bar at the bottom of the screen will display a green check mark, indicating that the tablet is connected to the VCI device.
10. To disconnect the device, tap the connected device again.
11. Tap **Back** on the top-left to return to the MaxiSys Job Menu.

NOTE

A VCI device can be paired with only one tablet at a time, and once it's been paired, the device will not be discovered by any other unit.

BAS Connection via Bluetooth

The MaxiBAS BT506 device needs to be either connected to a vehicle or to an available power source, so that it is powered up during the synchronization procedure. Make sure the tablet is fully charged or is connected to an external power supply.

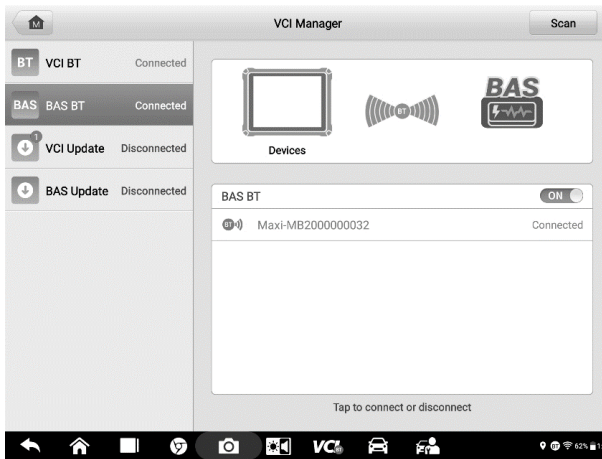

Figure 10-3 BAS Bluetooth Pairing Screen

- **To pair the BT506 series tester with the tablet**
 1. Press and hold the **Power** Button to turn on the MaxiSys Elite II. Ensure that the unit is sufficiently charged before using.
 2. Power on the MaxiBAS BT506.
 3. Enable **Bluetooth** on the MaxiSys Elite II by tapping **VCI Manager > BAS BT**,

and the tablet automatically scans for an available tester for Bluetooth pairing. The device name will appear as “Maxi” suffixed with a serial number.

4. Check the serial number of your BT506 series tester and select the desired device on the tablet for pairing.
5. When paired successfully, the connection status will read as “Connected”.
6. To disconnect the device, tap the connected device again.
7. Tap **Back** on the top-left to return to the MaxiSys Job Menu.

NOTE

A VCI device can be paired to only one tablet at a time, and once it's been paired, the device will not be discoverable by any other unit.

VCI Update

The VCI Update module provides the latest update for the VCI. Before updating the VCI, please make sure the tablet network is stable.

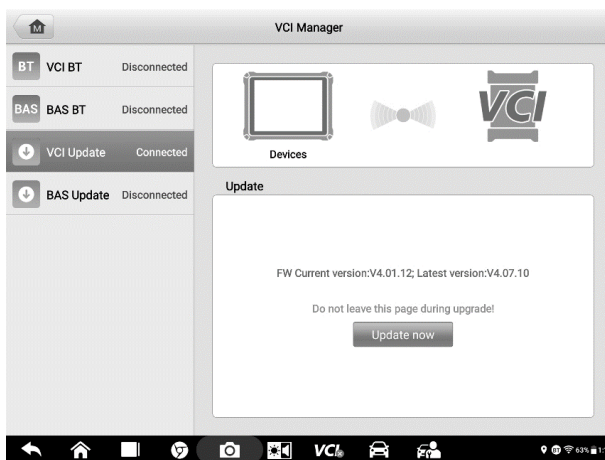

Figure 10-4 VCI Update Screen

➤ To update the VCI

1. Power on the tablet.
2. Connect the VCI device to the tablet via Bluetooth or USB.

3. Tap **VCI Manager** on the MaxiSys Job Menu of the tablet.
4. Select **VCI Update** from the connection mode list.
5. The current version and the latest version of the VCI will appear. Tap **Update Now** to update the VCI.

BAS Update

The BAS Update module provides the latest update for the MaxiBAS BT506. Before updating the BAS, please make sure the tablet network is stable.

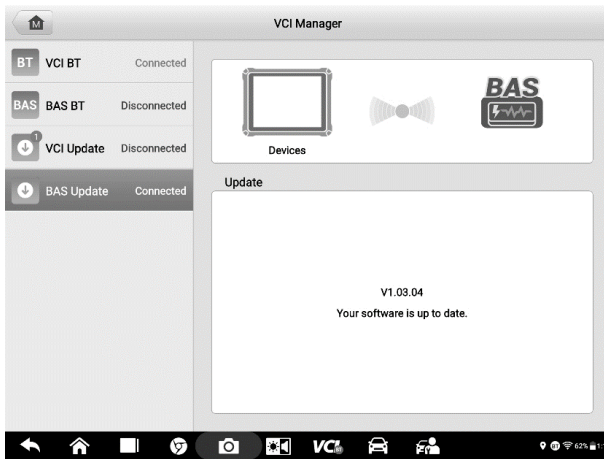

Figure 10-5 VCI Update Screen

➤ **To update the MaxiBAS BT506**

1. Power on the tablet and the MaxiBAS BT506.
2. Connect the MaxiBAS BT506 to the tablet via Bluetooth or USB.
3. Tap **VCI Manager** on the MaxiSys Job Menu of the tablet.
4. Select **BAS Update** from the connection mode list.
5. The current version and the latest version of the MaxiBAS BT506 will appear. Tap **Update Now** to update the MaxiBAS BT506.

12. Update

The internal programming of the MaxiSys Diagnostics System, known as the software, can be updated using the Update application. Updates increase the MaxiSys applications' capabilities, typically by adding new tests, new models, or enhanced applications to the database.

The tablet automatically searches for available updates for all of the MaxiSys components when it is connected to the Internet. Any updates that are found can be downloaded and installed on the device. This section describes installing an update to the MaxiSys Diagnostics System. A notification message displays if an update is available when the Notifications function is enabled in the Settings application.

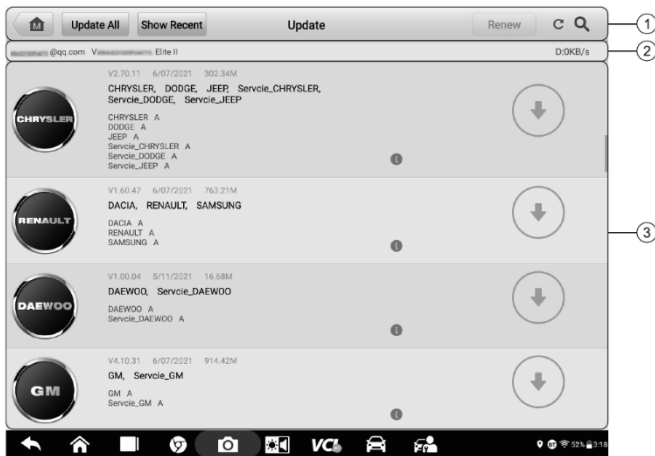

Figure 12-1 Update Screen

1. Navigation and Controls

- Home Button — return to the MaxiSys Job Menu.
- Update All — available updates for all tablet systems.
- Show Recent — shows the recent updates.
- Search Bar — searches specific update item by inputting the file name, for example: a specific vehicle manufacturer.

2. Status Bar

- Left Side — displays the MaxiSys device model information and serial number.

- Right Side — displays an update progress bar indicating the completion status.

3. Main Section

- Left Column — displays vehicle logos.
- Middle Column — displays a brief introduction about the new changes to the operation or capabilities. Tap  button to display an information screen to view more details, and tap the dim area around to close the window.
- Right Column — according to the operation status of each item, the icon appears differently.
 - a) Tap **Update** to update the selected item.
 - b) Tap **Pause** to suspend the update procedure.
 - c) Tap **Continue** to go on updating the suspended update.

➤ To update the tablet

1. Power up the tablet, and ensure that it is connected to a power source and has a steady Internet connection.
2. Tap the **Update** application button from the MaxiSys Job Menu, or tap the update notification message when received. The Update application screen appears.
3. Check all available updates:
 - To update all the items, tap the **Update All** button.
 - To update a specific item, tap the **Update** icon on the right column of the specific item. This option is highly recommended to ensure updates are performed correctly, especially if you are unsure of the speed and stability of your Internet connection.
4. Tap **Pause** to suspend the updating process. Tap **Continue** to resume the update and the process will continue from the pause point.
5. When the updating process is completed, the software will be installed automatically. The new version will replace the older version.

13. Support

This application launches the Support platform which synchronizes Autel's online service base station with the MaxiSys tablet. In order to synchronize the device to your online account, you need to register the product online when you use it for the first time. The Support application is connected to Autel's service channel and online communities that provides the quickest way for problem solutions, allowing you to submit complaints or send help requests to obtain direct service and support.

Product Registration

In order to get access to the Support platform and obtain update and other services from Autel, you are required to register the MaxiSys Diagnostics Device the first time you use it.

➤ To register the diagnostics device

1. Visit the website: <http://pro.autel.com>.
2. If you have an Autel account, sign in and skip to Step 7.
3. If you are a new member to Autel, tap **Register** to create an ID.
4. Enter your personal information. Fields marked with an asterisk (*) are mandatory.
5. After all the mandatory information is entered, read the **Autel User Service Agreement** and **Autel Privacy Policy**, then check the box to accept the terms and click **Register**.
6. Once your account is successfully registered, you will be redirected to the Product Registration screen. If not, click the button on the screen.
7. Your product serial number and password are required to enter. To find your serial number and password on the tablet: go to **Settings** > **About**.
8. Enter your tablet's serial number and password.
9. Enter the CAPTCHA code and click **Submit** to complete your product registration.

Support Screen Layout

The Support application interface is navigated by the **Home** button on the top navigation bar.

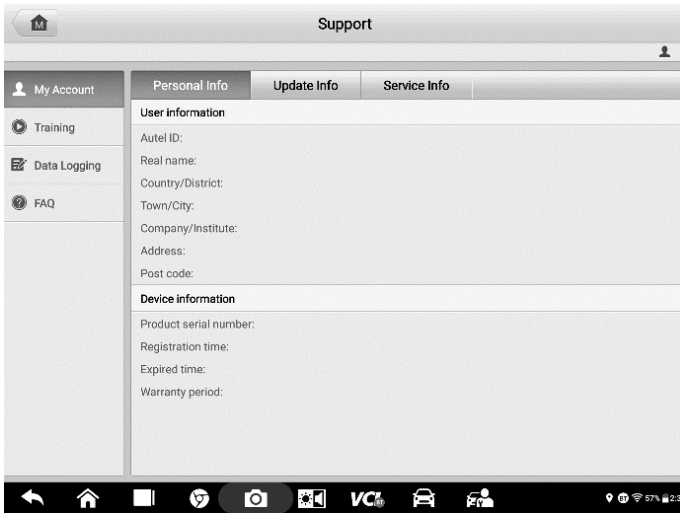

Figure 13-1 Support Application Screen

The main section of the Support screen is divided into two sections. The narrow column on the left is the main menu: selecting one subject from the main menu displays the corresponding function interface on the right.

My Account

The My Account screen displays comprehensive user and product information of the user and the product, which is synchronized with your account, including User Info, Device Info, Update Info, and Service Info.

Personal Info

The User Info and Device Info are both included under the Personal Info section.

- **User Information** — displays detailed information from your registered online Autel account, such as your Autel ID, name, address, and other contact information.
- **Device Information** — displays the registered product information, including the serial number, registration date, expire date, and warranty period.

Update Info

The Update Info section displays a detailed list of the product's software update history, including the product serial number, software version or name, and the update time.

Service Info

The Service Info section displays a detailed record list of the device's service history information. Each time the device is sent back to Autel for repair, the device's serial number and the detailed repair information, such as the fault type, changed components, or system reinstallation, will be recorded and updated to the associated online product account that will be available in the Service Info section.

Training

The Training section provides quick links to Autel's online video accounts. Select a video channel by language to see all available Autel online tutorial videos on such topics as product usage techniques and vehicle diagnostics practices.

Data Logging

The Data Logging section keeps records of all **Feedback** (submitted), **Not Feedback** (but saved) or **History** (up to the latest 20 test records) data logs on the diagnostics system. The support personnel will receive and process the submitted reports through the Support platform. The solution will be sent back within 48 hours. You may continue to correspond with Support until the issue is resolved.

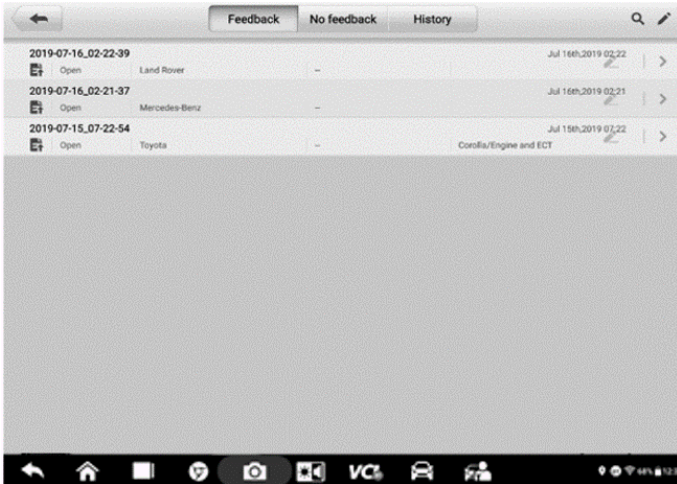

Figure 13-2 Data Logging Screen

- **To submit a reply in a Data Logging session**
 1. Tap the **Feedback** tab to view the submitted data loggings.
 2. Select the latest message from Autel support service.

3. Tap the input field at the bottom of the screen and enter your reply. Tap the **Audio** button to record a voice message. Tap the **camera** button to take a screenshot.
4. Tap **Send** to send your reply to Support.

FAQ Database

The FAQ section provides comprehensive references for all questions frequently asked and answered about the use of Autel's online member account, shopping, and payment procedures.

- **Account** — displays questions and answers about the use of Autel's online user account.
- **Shopping & Payment** — displays questions and answers about online product purchase and payment methods or procedures.

14. MaxiViewer

MaxiViewer allows you to search functions and the version information supported by our tools. There are two ways of searching, either by searching the tool and the vehicle or searching the functions.

➤ **To search by vehicle**

1. Tap the **MaxiViewer** application on the MaxiSys Job Menu. The **MaxiViewer** application screen displays.
2. Tap the tool name on the top-left to drop down the tool list, and tap the one you want to search.
3. Tap the vehicle brand, model, and year you want to search.

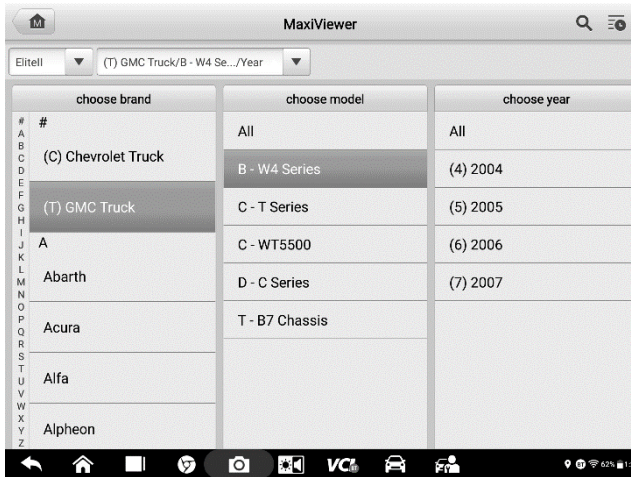

Figure 14-1 MaxiViewer Screen 1

4. All functions supported by the selected tool for the selected vehicle are displayed with vehicle's system, function, sub function, and more.

➤ **To search by the functions**

1. Tap the **MaxiViewer** application on the MaxiSys Job Menu. The MaxiViewer application screen displays.
2. Tap the tool name on the top-left to drop down the tool list, and tap the one you want to search.
3. Enter the function you want to search in the top-right search box. The screen will display all vehicles that support this function, along with information such as the vehicles' year, system, capacity, type, function, sub-function, and version.

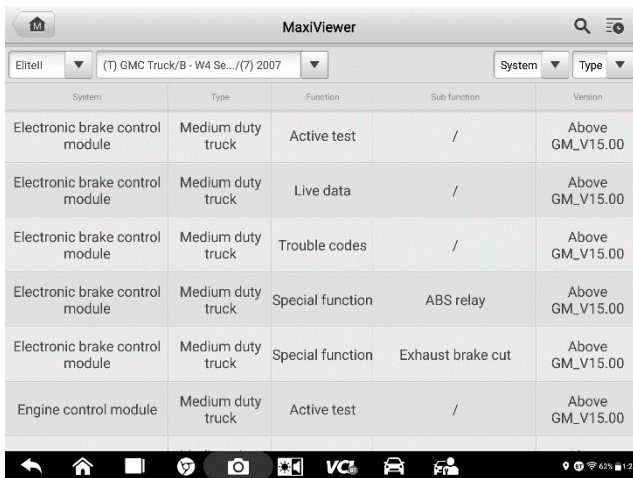

Figure 14-2 MaxiViewer Screen 2

NOTE

Fuzzy search is supported. Type in some part of the function-related keywords to find all available information.

15. MaxiVideo

The MaxiVideo application configures the MaxiSys Diagnostics Device to operate as a digital video scope by simply connecting the tablet to a MaxiVideo Camera. This function allows you to examine difficult-to-reach areas normally hidden from sight, with the ability to record digital still images and videos, which offers you an economical solution to inspect machinery, facilities, and infrastructure in a safe and quick way.

WARNING & IMPORTANT:

Follow these instructions to reduce the risk of injury from electric shock, entanglement and other causes and prevent tool damage.

- Do not place the imager head into anything or anywhere that may contain a live electric charge or moving parts, which increases the risk of electric shock or entanglement injuries.
- Do not use the imager head cable to modify surroundings, clear pathways or clogged areas.
- When inspection is completed, carefully withdraw the imager head from the inspected area.
- The imager head cable is waterproof to a depth of 3m (10'). Greater depths may cause leakage into the imager head cable, electric shock or tool damage.
- The working temperature of the imager head is between 32 °F (0 °C) and 113 °F (45 °C).

Check-Ups:

- ✓ **FOR AUTOMOBILES:** Ensure the automobile is not running during inspection to avoid damage from hot metal and liquid under the hood. Do not get oil or gasoline on the imager head.
- ✓ **FOR PIPES:** If you suspect that a metal pipe may carry electric charge, have a qualified electrician to check the pipe before inspecting it.
- ✓ **FOR WALLS:** Before you inspect the inside of a wall with the imager head, turn off the circuit breaker to the house.
- ✓ **WORK AREA:** Ensure the work area has sufficient light.

Additional Accessories

The MaxiVideo Camera and its fittings are the additional accessories. Both sizes (*8.5 mm* and *5.5 mm*) of the imager head are optional and available for purchase along with the standard MaxiSys tool kit.

MaxiVideo Camera

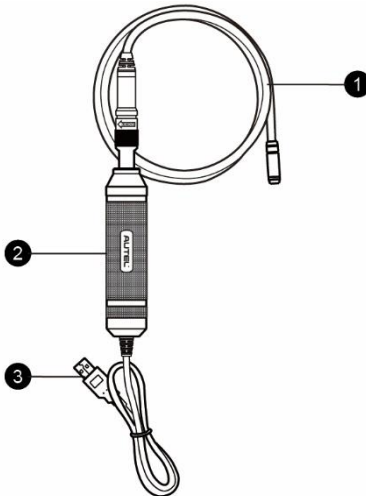

Figure 15-1 *MaxiVideo Camera*

1. Removable Imager Head Cable – connects to the tool when performing MaxiVideos for image and video viewing.
2. Handgrip — ergonomically designed handle for comfortable grips and agile operation.
3. USB Cable — connects the MaxiVideo Camera to the MaxiSys tablet.

Imager Head Accessories

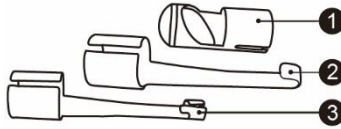

Figure 15-2 8.5 mm Imager Head Accessories

1. Mirror — helps to look around corners and see the unreachable areas.
2. Hook — unclogs obstacles and picks up wires in the pipes or confined areas.
3. Magnet — picks up small metal objects such as dropped rings or screws.

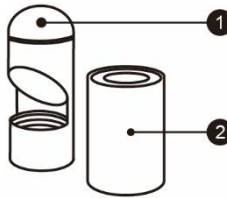

Figure 15-3 5.5 mm Imager Head Accessories

1. Mirror — helps to look around corners and see the unreachable areas.
2. Magnet — picks up small metal objects, such as dropped rings or screws.

Accessory Assembly

8.5 mm Imager Head

The three accessories, including the Magnet, Hook, and Mirror, can be attached to the Imager Head in the same manner described below:

1. Hold the accessory and the imager head.

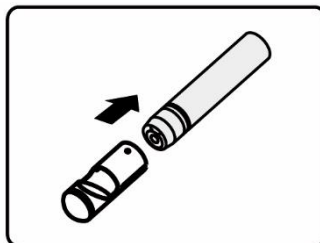

2. Slip the end of the accessory over the imager head and then fix the accessory.

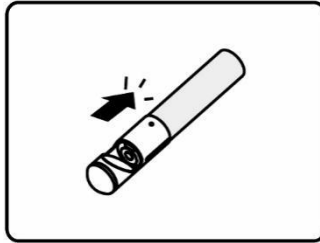

5.5 mm Imager Head

The two accessories, the Magnet and Mirror, can be attached to the Imager Head in the same manner described below:

1. Hold the accessory and the imager head.

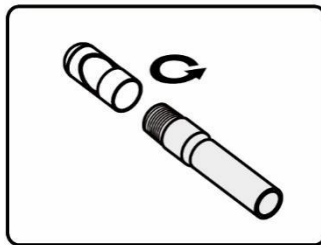

2. Screw the thread part of the accessory over the imager head to fix the accessory.

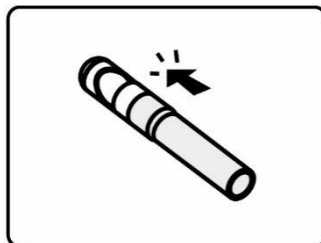

Technical Specifications

Table 15-1 *Specifications*

Item	Description
Optimal Viewing Distance	<ul style="list-style-type: none">● 0.79 to 2.36" (2 to 6 cm) with 8.5 mm-diameter imager head● 0.79 to 2.36" (2 to 6 cm) with 5.5 mm-diameter imager head
Resolution	<ul style="list-style-type: none">● JPG images (640 x 480)● AVI videos (320 x 240)
Operating Temperature	<ul style="list-style-type: none">● Main Unit: 0 to 55°C (ambient)● Cable: -10 to 70°C
Storage Temperature	-20 to 75°C (ambient)
Waterproof	Imager head and cable to 1 m
Weight	<ul style="list-style-type: none">● 0.3 kg for 8.5 mm diameter imager head● 0.2 kg for 5.5 mm diameter imager head

Operations

Before opening the MaxiVideo application, the imager head cable must be connected to the tablet using the USB cable. Install the correct imager head accessories according to the specific needs.

NOTE

When in operation, the imager head cable can be manipulated so as to better access confined or awkward spaces.

➤ **To take images using the MaxiVideo application**

1. Connect the imager head cable to the USB port on the top of the tablet.
2. If not already done, power up the tablet.
3. Tap the **MaxiVideo** application on the MaxiSys Job Menu. The MaxiVideo interface displays, showing a camera operating screen. The imager head camera is used by default.
4. Select the **Camera** icon at the lower-right corner to take images.

5. Focus the image to be captured in the view finder by adjusting and properly locating the imager head cable.
6. Tap the blue ring on the screen. The view finder now displays the captured picture and auto-saves the taken photo.
7. Tap the thumbnail image on the top-right corner of the screen to view the stored image. Slide the screen left and right to view the images.
8. Tap on the selected image and the edit toolbar instantly displays.
9. Tap the corresponding button to **share** or **delete** an image.
10. Tap the **Back** or **Home** button on the Navigation Bar at the bottom of the screen to exit the MaxiVideo application.

➤ **To record a video using the MaxiVideo application**

1. Connect the imager head cable to the USB port on the top side of the tablet.
2. If not already done, power up the tablet.
3. Tap the **MaxiVideo** application on the MaxiSys Job Menu. The MaxiVideo interface displays, showing a camera operating screen. The Imager head camera is used by default.
4. Select the **Video** icon at the lower-right corner to record a video.
5. Properly locate the imager head cable to focus the inspection scene for recording.
6. Tap the red ring on the operating screen to start recording.
7. Tap the red circle again to stop recording. The recorded video is automatically saved.
8. Tap the gallery icon at the bottom-right corner to review all recorded videos.
9. Select the corresponding button on the upper-right corner to search or delete a video.

16. Quick Link

The Quick Link application provides you with convenient access to Autel's official website and many other well-known sites in automotive service, which offers you abundant information and resources, such as technical help, knowledge bases, forums, training and expert consultations.

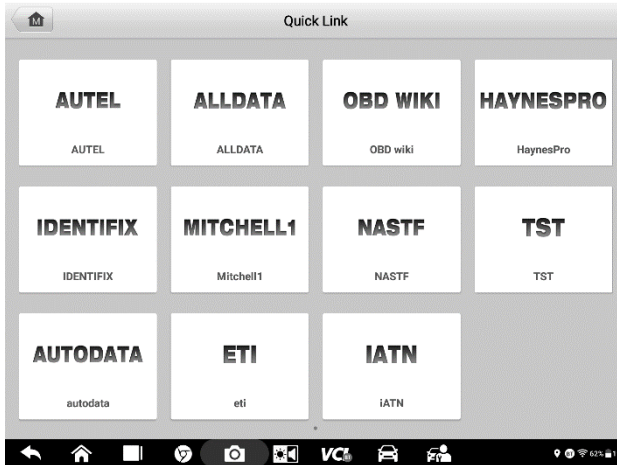

Figure 16-1 Quick Link Screen

➤ **To open a quick link**

1. Tap **Quick Link** on the MaxiSys Job Menu. The Quick Link application screen displays.
2. Select a website thumbnail from the main section. The Chrome browser is launched and the selected website is opened.
3. Now you can start exploring the website.

17. Remote Desktop

The Remote Desktop application launches the TeamViewer Quick Support program, which is a simple, fast and secure remote control interface. You can use the application to receive ad-hoc remote support from Autel's support center, colleagues or friends, by allowing them to control your MaxiSys tablet on their PC via the TeamViewer software.

Operations

If you think of a TeamViewer connection as a phone call, the TeamViewer ID would be the phone number, under which all TeamViewer Clients can be reached separately. Computers and mobile devices that run TeamViewer are identified by a globally unique ID. The first time the Remote Desktop application is started, this ID is generated automatically based on the hardware characteristics and will not change.

Make sure the tablet is connected to the Internet before launching the Remote Desktop application, so that the tablet is able to receive remote support from the third party.

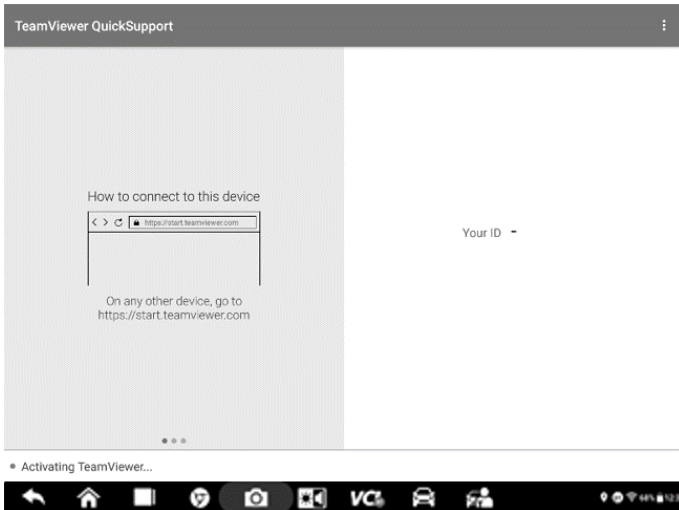

Figure 17-1 Remote Desktop Screen

➤ **To receive remote support from a partner**

1. Power on the tablet.
2. Tap the **Remote Desktop** application on the MaxiSys Job Menu. The TeamViewer interface displays and the device ID is generated and shown.
3. Your partner must install the Remote Control software to the computer by downloading the TeamViewer full version program online (<http://www.teamviewer.com>). Start the software on the computer at the same time in order to provide support and take control of the tablet remotely.
4. Provide your ID and wait for your partner to send you a remote control request.
5. A message displays to ask for your confirmation to allow remote control on your device.
6. Tap **Allow** to accept, or tap **Deny** to reject.

Refer to the associated TeamViewer documents for additional information.

18. MaxiScope

The MaxiScope application configures the MaxiSys Diagnostic Device to operate as an automotive oscilloscope when working in combination with the MaxiScope module. This function provides all the features needed for performing electrical and electronic circuit tests as well as monitoring signal activities on any modern vehicles, which shows you what is really going on with a vehicle's electrical system.

Safety Information

Follow these instructions to reduce the risk of injury from electric shock and prevent equipment damage.

A. Maximum input ranges

Observe all terminal ratings and warnings marked on the product.

DANGER:

- To prevent electric shock, operate within the safe input range for the scope.
- To prevent electric shock, take all necessary safety precautions when working on equipment where voltages above the specified input range may be present. Contact with voltages outside of the specified measuring range presents a risk of electric shock.
- To prevent injury or death, the oscilloscope must not be directly connected to the mains (line power). To measure mains voltages, use a differential isolating probe specifically rated for mains use.

WARNING:

- Operation outside of the safe input range is likely to cause permanent damage to the oscilloscope and other connected equipment.

B. Grounding

DANGER:

- The scope's ground connection through the USB cable is for measurement purposes only. The oscilloscope does not have a protective safety ground.
- Do not connect the ground input (chassis) to any electrical power source. To prevent personal injury or death, use a voltmeter to check that there is no

significant AC or DC voltage between the oscilloscope ground and the point to which you intend to connect it.

 **WARNING:**

- Applying a voltage to the ground input is likely to cause permanent damage to the oscilloscope, the attached computer, and other equipment.
- To prevent measurement errors caused by poor grounding, always use the high-quality USB cable supplied with the oscilloscope.

C. External connections

 **DANGER:**

- To prevent injury or death, use only the power cord and adaptor supplied with the product.

D. Environment

 **DANGER:**

- To prevent injury or death, do not use in wet or damp conditions, or around explosive gas or vapor.

 **WARNING:**

- To prevent damage, always use and store your oscilloscope in appropriate environments. For detailed information on temperature and humidity specifications for both the storage and usage of the oscilloscope.

E. Product Maintenance

The product contains no user-serviceable parts. Repair, servicing and calibration require specialized test equipment and must only be performed by Autel Tech Support or an approved service provider.

 **DANGER:**

- To prevent injury or death, do not use the product if it appears to be damaged in any way, and stop use immediately if you are concerned by any abnormal operations.

 **WARNING:**

- Do not tamper with or disassemble the oscilloscope, connectors or accessories. Internal damage will affect performance.
- Do not block any of the instrument's air vents, as overheating will cause damage to the oscilloscope.
- When cleaning the oscilloscope, use wet soft cloth with mild detergent in water.

Do not allow water to enter the oscilloscope casing, as this will cause damage to the electronics inside.

Glossary

AC/DC Control

Each channel can be set to either AC coupling or DC coupling. With DC coupling, the voltage displayed on-screen is equal to the true voltage of the signal with respect to ground. With AC coupling, any DC component of the signal is filtered out, leaving only the variations in the signal for the AC component.

Aliasing

When the signal frequency gets higher than half the scope's maximum sampling rate and exceeds the limit, a distorted waveform appears. This distortion is called aliasing.

Analog Bandwidth

All oscilloscopes have an upper limit to the range of frequencies at which they can measure accurately. The analog bandwidth of an oscilloscope is defined as the frequency at which a displayed sine wave has half the power of the input sine wave (about 71% of the amplitude).

Block Mode

A sampling mode in which the computer prompts the oscilloscope to collect a block of data into its internal memory before stopping the oscilloscope and transferring the whole block into computer memory. This mode of operation is effective when the input signal being sampled is high frequency.

Buffer Size/Cache Size

This term indicates the size of the oscilloscope's buffer memory. The buffer memory is used by the oscilloscope to temporarily store data. This helps to compensate for the differences in data transfer rate from one device to another.

Sampling Rate

This term is used to define the number of samples per second captured by the oscilloscope. The faster the sampling rate of the scope, the more frequently it measures the signal voltage, and so the more detailed will be the trace that appears on the scope screen.

Streaming Mode

This term indicates a sampling mode in which the oscilloscope samples data and returns it to the computer in an unbroken stream. This mode of operation is effective when the input signal being sampled is at low frequency.

Time Base

The time base controls the time interval across the scope display.

Voltage Range

The voltage range is the range between the maximum and minimum voltages that can be accurately captured by the oscilloscope.

Sinusoidal Waveform

This term describes the waveform characteristics typically found in circuits with large inductance and capacitance, and often referred to as an AC signal. The waveform alternates either side of 0 volts or may rise and fall creating a regular sinusoidal shape:

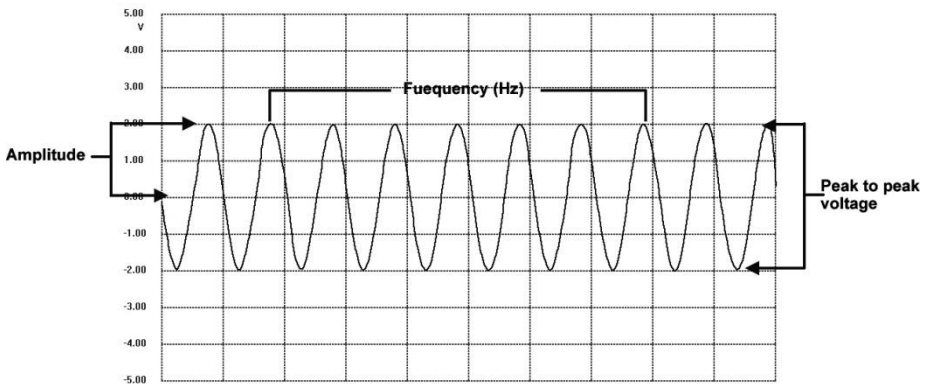

Figure 18-1 Sinusoidal Waveform

Amplitude

This term indicates the maximum voltage generated from the zero volts line of the oscilloscope.

Frequency

This term describes the number of signal occurrences per second. Frequency is measured in Hz (hertz).

Square Waveform

This term describes the waveform characteristics normally generated by signals switching between clearly defined voltage levels, such as a Hal effect sensor signal may create by switching a voltage to ground. A typical digital square waveform is shown below:

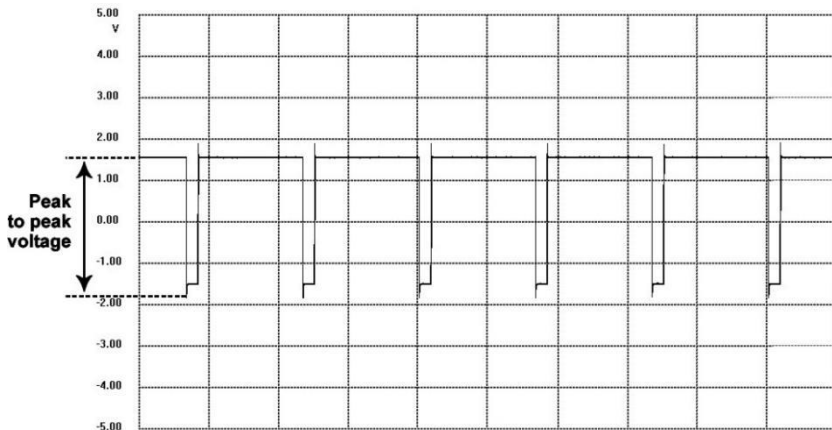

Figure 18-2 Square Waveform

Peak to peak voltage

This term indicates the difference in voltage between the minimum and maximum voltages occurring in the waveform.

MaxiScope Module

The MaxiScope Automotive Oscilloscope tool kit is optional and available for purchase along with the MaxiSys package. There are 2 versions (basic and advanced versions) available.

The MaxiScope tool kit comes standard with:

- MaxiScope Module
- USB Cable
- Other probe accessories

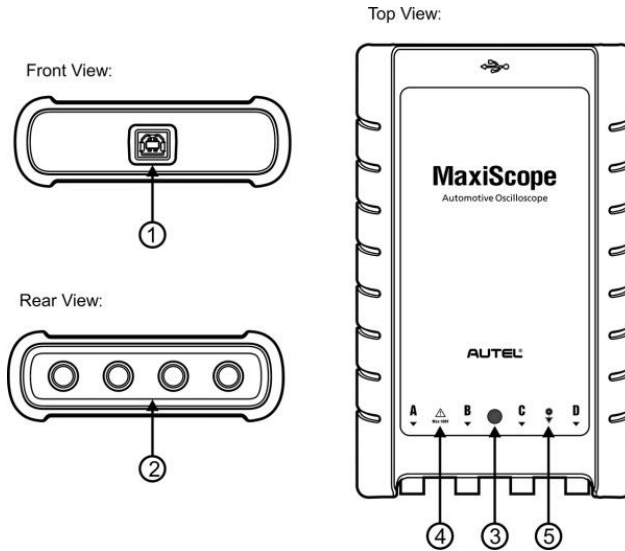

Figure 18-3 MaxiScope Front, Rear, and Top View

1. **USB Port**
2. **Input Channel A/B/C/D**
3. **LED Indicator Light** — lights up when powered on, blinks when communicating, and shimmers when error occurs
4. **Warning Triangle** — indicates potential safety hazard that exists on the indicated connections, and appropriate precautions should be taken. Make sure you read through the [Safety Information](#) before use.
5. **Equipotential Symbol** — indicates the outer shells of the indicated BNC connectors are all at the same potential. Therefore, necessary precautions should be taken to avoid applying a potential through the return connections of the indicated BNC terminals, as this may result in a large current flow, causing damage to the product and the connected equipment.

Power Source

The MaxiScope MP408 Scope Module is powered directly by the USB port of the connected PC, no batteries or power leads are required, making it suitable for both workshop-based and mobile automotive diagnostics.

Technical Specifications

Table 18-1 Technical Specifications

Items	Description
Vertical resolution	12 bits
Channels	4
Bandwidth	20 MHz
Accuracy	<ul style="list-style-type: none"> ● Voltage: 1% ● Time: 50 ppm
Sensitivity	10 mV/div to 20 V/div
Input Ranges (full scale)	±50 mV to ±100V in 11 ranges
Input Impedance	1 MΩ in parallel with 22pF
Input Type	Single-ended, BNC connector
Input Coupling	Software selectable AC/DC
Overload Protection	±200 V on single input
Maximum Sampling Rate (Single Shot) 1 or 2 channels in use 3 or 4 channels in use	<ul style="list-style-type: none"> ● 80 MS/s* ● 20 MS/s
Buffer Memory	32 M samples shared among active channels
Waveform Buffer	Up to 1000 waveforms
Timebase Ranges	100 ns/div to 1000 s/div
Advanced Features	Math channels, Measurements

Triggers	Description
Source	Any input channel
Basic Triggers	Auto, Normal, Single, None
Advanced Triggers	Rising edge, Falling edge
Environmental	Description
Operating Temperature Range	0 to 50°C (15 to 40°C for quoted accuracy)
Storage Temperature Range	-20 to 60°C
Storage Humidity Range	5 to 95%RH, Non-condensing
Physical Characteristics	Description
Dimensions (Protection rubber case included)	190 mm X 115 mm X 38 mm
Weight	<0.5 kg
General	Description
PC Interface	USB 2.0 – cable supplied
Power Requirements	Powered from USB port
Compliance	FCC (EMC), CE (EMC and LVD), RoHS
Warranty	1 year

 **NOTE**

Reduced to 20MS/s if channels A and B, or C and D are enabled.

Screen Layout and Operations

The MaxiScope application works as a signal processing program that displays the shape of electrical signals on-screen with a live graph showing voltage against time. The grid on the screen shows divisions of voltage and time to enable measurements to be made.

Units of voltage per division are shown down the side of the scope screen while units of time per division are shown along the bottom. The graph is referred to as a waveform and the scope repeatedly draws the trace across the screen from left to right.

Before performing the MaxiScope application, the MaxiScope Module must be connected to the tablet. Apply appropriate probe accessories supplied with the MaxiScope tool kit for use in various tests.

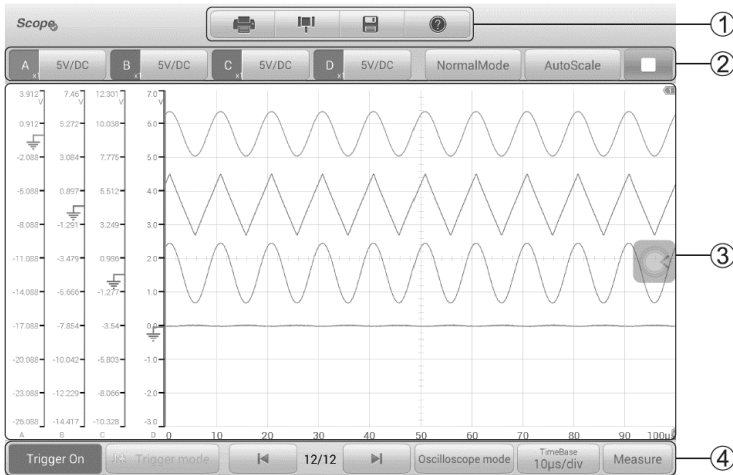





Figure 18-4 Oscilloscope Application Screen Layout

1. **Top Toolbar** — used for configurations of various settings and operations of the scope
2. **Function Buttons** on the top — used for configurations of channel activation, measurement scale and trigger settings
3. **Measurement Grid** — displays measurements of voltage against time
4. **Function Buttons** at the bottom — used for configurations of trigger, time base, and measurement parameter display settings.

Top Toolbar

The top toolbar contains various function buttons with options for operations and configurations of the MaxiScope, the operations of which are described in the table below:

Table 18-2 Toolbar Buttons

Button	Name	Descriptions
	Print	Saves and prints a copy of the displayed data.
	Tool	<p>Tapping this button opens a settings window with options to configure various measurement tools for reference and assessment of data analysis:</p> <ul style="list-style-type: none"> • Tap Select a Math Channel to select a match channel. • Tap Select a Probe to select a predefined probe. • Tap Cache Setting to set the cache.
	Save	<p>Tapping this button opens a submenu, on which 5 options will display, allowing you to save, record, and play back the waveform data.</p> <ul style="list-style-type: none"> • Tap Save current page to take a screenshot image. • Tap Record data to save the current waveform data. • Tap Save Ref to save a copy of an existing signal waveform as reference. • Tap Review data allows selecting and reviewing the previously stored waveform recordings. • Tap Recall Ref to retrieve the saved reference waveforms. <p>All saved images are stored in the Data Manager application for later reviews.</p>

Button	Name	Descriptions
	Help	Provides instructions or tips for operations of various functions.

Math Channel

A math channel is a virtual channel generated by mathematical function of the input channel. It can be displayed in a scope in the same way as an input signal, and like an input signal, it has its own measure axis, scaling, and color. The MaxiScope module has a set of built-in math channels for the most important functions, including “A+B” (the sum of channels A and B) and “A-B” (the difference between channels A and B).

➤ **To use a math channel:**

1. Tap the **Tool** button in the Top Menu.
2. Tap the **Select a Math Channel** option on the left column.
3. Tap the desired option on the right column to enable the math channel in the channel list.
4. The Math Channel displays on the MaxiScope screen.

Probe

A probe is any transducer, measuring device or other accessory that you connect to an input channel of your MaxiScope module.

Reference Waveform

A Reference Waveform is a copy of an existing signal waveform saved as a reference. It can be retrieved to display as a comparative reference to examine a live signal. Up to 4 reference waveforms can be saved.



Figure 18-5 Ref. Waveform Save Window

➤ **To create a Reference Waveform:**

1. Tap the **Tool** button in the Top Menu.
2. Select **Save Ref.** in the dropdown menu.
3. Select the channel, to which the desired waveform belongs.
4. Name the reference waveform by selecting R1, R2, R3 or R4 in the pop-up window.
5. Tap on the **Yes** icon to save, or **No** icon to cancel.

Recall Reference

The saved reference waveforms can be retrieved by tapping Recall Ref in the dropdown menu of the Tool button.

➤ **To recall reference waveforms:**

1. Tap **Tool** button on the Top Menu.
2. Select **Recall Ref** in the dropdown menu and a pop-up window will display. Available reference waveform items are highlighted in blue.
3. Select the desired reference waveform by ticking the check box alongside.
4. Tap **Yes** and the selected reference waveform will appear on the scope screen.

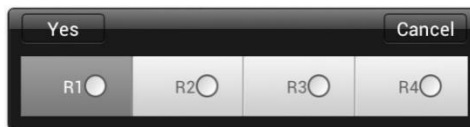

Figure 18-6 Recall Reference Waveform Window

Function Buttons

This group of buttons is used for configurations of channel activation, measurement scale, and trigger settings. The operations of which are described below:

- **Channel Control Buttons A/B/C/D** — tapping each button allows you to activate or deactivate the corresponding channel; long pressing the button opens a window, which allows you to select and configure appropriate probes for specific tests.

The Channel Control Buttons are displayed in different colors as follows:

- A. Red
- B. Green
- C. Blue
- D. Pink

● **AC/DC Coupling and Voltage Scale Buttons** — tapping this button opens a dropdown menu, on which you can select AC or DC measurements and adjust voltage measurement scales.

The **Auto voltage scale** option enables the scope to adjust the voltage scale automatically to capture the signal.

● **AutoScale** — tapping this button enables automatic set-up of the voltage scale and time base for the signals received.

● **Start/Stop** — tapping this button turns on/off the scope.

● **Single** — tapping this button activates the Single trigger mode when the trigger is on. The Single trigger mode configures the trigger to occur once when the scope captures the first signal waveform by the preset trigger point.

Measurement Grid

The 2 control features — Voltage per division and Time per division — enable the users to adjust the scope settings to suit the particular test measurement.

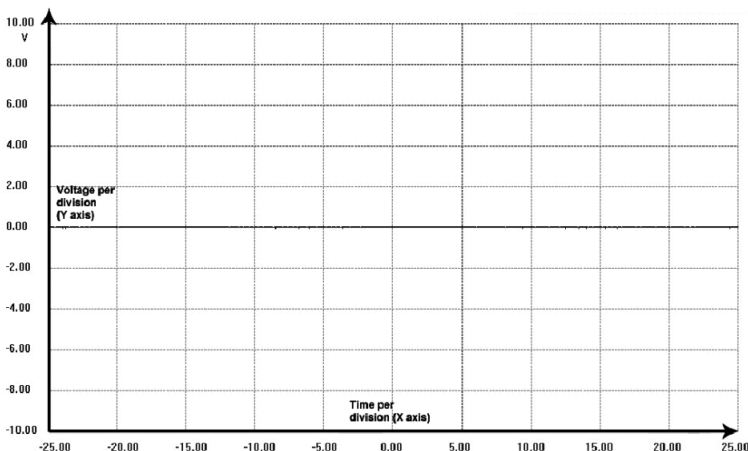

Figure 18-7 Measurement Grid

- **Voltage per division** — shown down the left side of the screen, referred to as the Y-axis
- **Time per division** — shown along the bottom of the screen, referred to as the X-axis

Multiple Scope Channels

The MaxiScope software features multiple channel display which enables more than one waveform to be displayed at the same time. It is useful for making comparisons among different signals. The voltage per division for each channel is adjusted individually while the time base per division is the same for all channels.

➤ To adjust the voltage scale

1. Tap the specific Y-axis of the corresponding channel to enable scale adjustment. The selected Y-axis is highlighted with thicker dividing line.
2. Adjust the voltage scale of the selected channel with the typical two-finger zoom gestures.
3. The 0 volts is hinted with a pointer reference line. Slide the pointer line up and down to move and view different areas of the scale.
4. Tap once on the screen area outside of the Y-axis to finish the voltage scale adjustment.

➤ To adjust the time base scale

1. Unselect the Y-axis if it's activated.
2. Use two fingers to adjust the time base with the typical zoom gestures on the measurement grid area.

Measurement Rulers

The Measurement Rulers allow the voltage and time duration of a waveform to be measured precisely. There are 2 kinds of measurement rulers: the vertical **Time Ruler** and the horizontal **Voltage Ruler**.

Tap on the **Ruler Activator** on the bottom-right corner of the measurement grid and drag it across the screen to the desired position. A **Time Ruler** is generated.

The **Voltage Ruler** can be generated in the similar way by tapping the **Ruler Activator**

on the top-left corner and dragging it downwards.

When **Measurement Rulers** are generated, a **Ruler Table** showing time and voltage values for the corresponding channels will be displayed. The **Delta** icon refers to the absolute difference between the values of the 2 rulers, which can be locked by tapping the **Lock** icon.

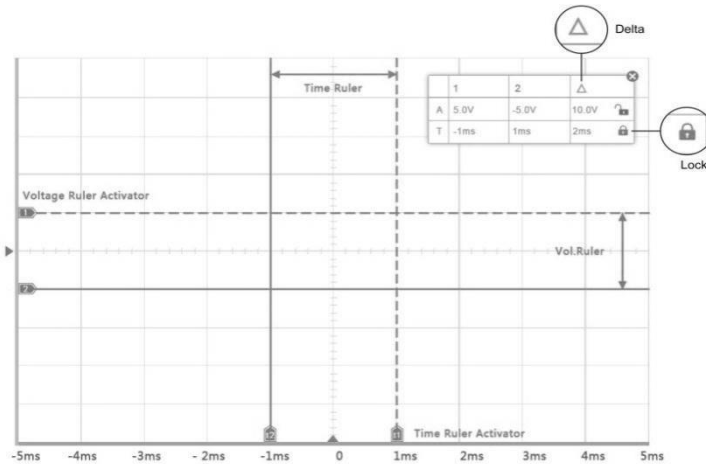

Figure 18-8 Measurement Rulers Display

Function Buttons

This group of buttons includes trigger setting buttons allowing you to set trigger source and trigger mode, a **Time base** button for adjustment, and a **Measurement** button with options for various measurement types.

- **Trigger On/Off** — taps to turn on/off the trigger. The button displays as **Trigger Off** when it is activated, and vice versa.

Once the trigger is activated, a voltage scale reference line and a time base reference line will be displayed on the measurement grid. The cross point of the 2 lines indicates the trigger point, allowing users to adjust its position by moving each of the 2 lines.

- **Trigger Source** — assigns the trigger to a specific channel
- **Trigger Slope** — sets trigger to occur by rising or falling voltage edges

- **Trigger Mode** — configures the trigger mode:

A. **Normal Mode** — configures the trigger to occur every time when the captured signal waveform reaches the trigger point, so the scope starts to draw the waveform when the signal reaches the trigger point.

B. **Auto Mode** — configures the trigger to occur every time when the scope captures the signal waveforms by the preset trigger point. The scope continues to draw the waveforms even when the signal is not in the trigger point range.

- **Main Time Base** — allows users to select an appropriate time per division. The time per division (10 divisions) is displayed along the bottom of the screen. The time base adjustment affects all of the active scope channels at once.

- **Measure** — allows users to select various types of measurement parameters to be displayed at the right side of the screen for reference.

A maximum of 5 items are allowed to be selected each time.

➤ **To set a specific trigger point**

1. Tap the **Trigger On** button to activate the trigger.
2. Configures the specific trigger source, the trigger slope, and the trigger mode according to the test demand.
3. Tap and slide the voltage scale reference line up or down to the desired voltage point. The voltage info is displayed in a small reference box.
4. Tap and slide the time base reference line left or right to the desired point.
5. Tap **Start** button on the top-right side of the screen to activate the scope

Troubleshooting

If the MaxiScope is not communicating with the tablet, you need to do the followings:

- Check if the MaxiScope is properly connected to the tablet through the supplied USB cable.
- If the MaxiScope is already connected to the tablet, but the communication between the devices has failed, tap the **Scope** icon on the top-right side of the screen to reset the USB connection.

! IMPORTANT

All vehicle communications must be terminated before resetting the USB connection to avoid damage to the devices and the vehicle. The Internet connection may be aborted during USB reset.

- If the communication between the MaxiScope and the tablet still fails after USB reset, restart the tablet and reconnect the MaxiScope.

MaxiScope Firmware Update

The operating software of the MaxiScope is continuously being developed, and the update package can be downloaded free from the MaxiScope product webpage on Autel's website: <http://www.autel.com>.

19. User Feedback

The User Feedback feature allows you to submit questions related to this product.



Figure 19-1 User Feedback Screen

➤ **To send new user feedback**

1. Register the product online.
2. Tap **User Feedback** on the MaxiSys Job Menu. The device information is automatically synchronized with the online account.
3. Enter your telephone number/email address, feedback type, theme, and problem description. You can also attach a voice recording, photo, photo album, screen captures, image or PDF files to the form. To help us resolve the issue more efficiently, we recommend you complete the form with as much details as possible.
4. Tap **Submit** to send the completed form to Autel's online service center. The submitted feedback will be carefully read and handled by our service personnel.

20. Maintenance and Service

To ensure that the tablet and the combined VCI unit perform at their optimum level, we advise that the product maintenance instructions in this section are strictly followed.

Maintenance Instructions

The following includes how to maintain your devices, together with precautions to take.

- Use a soft cloth dampened with alcohol or mild glass cleaner to clean the tablet touchscreen at the end of each work day.
- Do not use any abrasive cleansers, detergent or automotive chemicals on the tablet.
- Keep the devices in dry conditions and within specified operating temperatures.
- Dry your hands before using the tablet. The touchscreen of the tablet may not work when it is moist, or when you tap the touchscreen with wet hands.
- Do not store the devices in humid, dusty or dirty areas.
- Check the housing, wiring, and connectors for dirt and damage before and after each use.
- Do not attempt to disassemble your tablet or the VCI unit.
- Do not drop or cause severe impact to the devices.
- Use only authorized battery chargers and accessories. Any malfunction or damage caused by the use of unauthorized battery charger or accessories will void the limited product warranty.
- Ensure that the battery charger does not contact conductive objects.
- Do not use the tablet beside microwave ovens, cordless phones and certain medical or scientific instruments to prevent signal interference.

Troubleshooting Checklist

- A. When the tablet does not work properly:
- Make sure the tablet has been registered online.

- Make sure the system software and diagnostic application are properly updated.
- Make sure the tablet is connected to the Internet.
- Check all cables, connections, and indicators to see if the signal is being received.

B. When battery life is shorter than usual:

- This may happen when you are in an area with low signal strength. Turn off your device if it is not in use.

C. When you cannot turn on the tablet:

- Make sure the tablet is connected to a power source or the battery is fully charged.

D. When you are unable to charge the tablet:

- Your charger maybe out of order. Contact your local dealer.
- You may be attempting to use the device in an overly hot/cold temperature. Charge the device in a temperate area.
- Your device may not be connected to the charger properly. Check the connector.

 **NOTE**

If the problems persist, please contact Autel's technical support personnel or your local selling agent.

About Battery Usage

Your tablet is powered by a built-in lithium-ion polymer battery, which enables you to recharge your battery when there is electricity left.

 **DANGER**

The built-in lithium-ion polymer battery is factory-replaceable only. Incorrect replacement or tampering with the battery pack may cause an explosion.

- Do not use a damaged battery charger.
- Do not disassemble, open, crush, bend, deform, puncture, or shred the battery.
- Do not modify, remanufacture or attempt to insert foreign objects into the battery, or expose the battery to fire, explosion, or other hazards.
- Only use the specified charger and USB cables. Use of non-Autel-authorized charger or USB cables may lead to device malfunction or failure.

- Use of an unqualified battery or charger may present a risk of fire, explosion, leakage, or other hazards.
- Avoid dropping the tablet. If the tablet is dropped, especially on a hard surface, and you suspect damage, take the tablet to a service center for inspection.
- Try to keep closer to your wireless router to reduce battery usage.
- The time needed to recharge the battery varies depending on the remaining battery capacity.
- Battery life inevitably shortens over time.
- Unplug the charger once the tablet is fully charged since overcharging may shorten battery life.
- Keep the battery in temperate environments. Do not place it inside a car when it is too hot or too cold, which may reduce the capacity and life of the battery.

Service Procedures

This section provides information on technical support, repair service, and application for replacement or optional parts.

Technical Support

If you have any question or problem on product operations, please contact us.

AUTEL NORTH AMERICA

- **Phone:** 1-855-AUTEL-US (288-3587) (Monday-Friday, 9AM-9PM Eastern Time)
- **Website:** www.autel.com
- **Email:** ussupport@autel.com; sales@autel.com; careers@autel.com
- **Address:** 36 Harbor Park Drive, Port Washington, New York, USA 11050

AUTEL EUROPE

- **Phone:** +49(0)89 540299608 (Monday-Friday, 9:00AM-6:00PM Berlin Time)
- **Website:** www.autel.eu
- **Email:** salesoffice.eu@autel.com; support.eu@autel.com
- **Address:** Landsberger Str. 408, 4. OG, 81241 München, Germany

AUTEL CHINA HQ

- **Phone:** +86-0755-8614-7779 (Monday-Friday, 9:00AM-6:00PM Beijing Time)
- **Website:** www.auteltech.cn
- **Email:** support@auteltech.net; sales@auteltech.net
- **Address:** 7-8th, 10th Floor, Building B1, Zhiyuan, Xueyuan Road, Xili, Nanshan, Shenzhen, 518055, China

AUTEL LATIN AMERICA

- **Phone:** +52 33 1001 7880 (Spanish in Mexico), +55 19 97816 4911 (Portuguese in Brazil)
- **Website:** www.autel.com
- **Email:** sales.latin@autel.com; latsupport02@autel.com
- **Address:** Avenida Americas 1905, 6B, Colonia Aldrete, Guadalajara, Jalisco, Mexico

AUTEL APAC

- **Phone:** +81-045-548-6282 (in Japan)
- **Website:** www.autel.com/jp/
- **Email:** sales.jp@autel.com; support.jp@autel.com
- **Address:** 6th Floor, Ari- Nadoribiru 3-7-7, Shin-Yokohama, Kouhoku-Ku, Yokohama-Shi, Kanagawa-Ken, 222-0033 Japan

AUTEL IMEA DMCC

- **Phone:** +971 585 002709
- **Website:** www.autel.com
- **Email:** sales.imea@autel.com; imea-support@autel.com
- **Address:** 906-17, Preatoni Tower (Cluster L), Jumeirah Lakes Tower, DMCC, Dubai, UAE

For technical assistance in other markets, please contact your local selling agent.

Repair Service

If it is necessary to send back your device for repair, please download and fill out the repair service form from www.autel.com. The following information must be included:

- Contact name
- Return address
- Telephone number
- Product name

- Complete description of the problem
 - Proof-of-purchase for warranty repairs
 - Preferred method of payment for non-warranty repairs
-

 **NOTE**

For non-warranty repairs, payment can be made with Visa, Master Card, or with approved credit terms.

Send the device to your local agent, or to the address below:

7-8th, 10th Floor, Building B1, Zhiyuan,
Xueyuan Road, Xili, Nanshan,
Shenzhen, 518055, China

Other Services

You can purchase the accessories directly from authorized tool suppliers of Autel, or your local distributor or agent.

Your purchase order should include the following information:

- Contact information
- Product or part name
- Item description
- Purchase quantity

21. Compliance Information

FCC Compliance

FCC ID: WQ8-ELITEII

This equipment has been tested and verified to comply with the limits for a Class B digital device, pursuant to Part 15 of the FCC Rules. These limits are designed to provide reasonable protection against harmful interference in a residential installation. This equipment generates uses and can radiate radio frequency energy and, if not installed and used in accordance with the instructions, may cause harmful interference to radio communications. However, there is no guarantee that interference will not occur in a particular installation. If this equipment does cause harmful interference to radio or television reception, which can be determined by turning the equipment off and on, the user is encouraged to correct the interference by one or more of the following measures:

- Reorient or relocate the receiving antenna.
- Increase the separation between the equipment and receiver.
- Consult the dealer or an experienced radio/TV technician for help.

This device complies with part 15 of the FCC Rules. Operation is subject to the following two conditions:

- (1) This device may not cause harmful interference, and
- (2) This device must accept any interference received, including interference that may cause undesired operation.

Changes or modifications not expressly approved by the party responsible for compliance could void the user's authority to operate the equipment.

SAR:

The radiated output power of this device is below the FCC radio frequency exposure limits. Nevertheless, the device should be used in such a manner that the potential for human contact is minimized during normal operation.

The exposure standard for wireless devices employs a unit of measurement known as the Specific Absorption Rate, or SAR. The SAR limit set by the FCC is 1.6 W/Kg. Tests for SAR are conducted using standard operating positions accepted by the FCC with the device transmitting at its highest certified power level in all tested frequency bands. Although the SAR is determined at the highest certified power level, the actual SAR level

of the device while operating can be well below the maximum value. This is because the device is designed to operate at multiple power levels to use only the power required to reach the network. To avoid the possibility of exceeding the FCC radio frequency exposure limits, human proximity to antenna should be minimized.

22. Warranty

12-Month Limited Warranty

Autel Intelligent Technology Corp., Ltd. (the Company) warrants to the original retail purchaser of this MaxiSys Diagnostics Device that should this product or any part thereof during normal usage and under normal conditions be proven defective in material or workmanship that results in product failure within twelve (12) months period from the date of purchase, such defect(s) will be repaired, or replaced (with new or rebuilt parts) with Proof of Purchase, at the Company's option, without charge for parts or labor directly related to the defect(s).

The Company shall not be liable for any incidental or consequential damages arising from the use, misuse, or mounting of the device. Some states do not allow limitation on how long an implied warranty lasts, so the above limitations may not apply to you.

This warranty does not apply to:

- a) Products subjected to abnormal use or conditions, accident, mishandling, neglect, unauthorized alteration, misuse, improper installation or repair or improper storage;
- b) Products whose mechanical serial number or electronic serial number has been removed, altered or defaced;
- c) Damage from exposure to excessive temperatures or extreme environmental conditions;
- d) Damage resulting from connection to, or use of any accessory or other product not approved or authorized by the Company;
- e) Defects in appearance, cosmetic, decorative or structural items such as framing and non-operative parts.
- f) Products damaged from external causes such as fire, dirt, sand, battery leakage, blown fuse, theft or improper usage of any electrical source.

⚠ IMPORTANT

All contents of the product may be deleted during the process of repair. You should create a back-up copy of any contents of your product before delivering the product for warranty service.
