

## Trademarks

Autel®, MaxiSys®, MaxiCheck®, MaxiDAS®, MaxiDiag®, MaxiRecorder®, MaxiScan®, and MaxiTPMS® are trademarks of Autel Intelligent Technology Corp., Ltd., registered in China, the United States and other countries. All other marks are trademarks or registered trademarks of their respective holders.

## Copyright Information

No part of this manual may be reproduced, stored in a retrieval system or transmitted, in any form or by any means, electronic, mechanical, photocopying, recording, or otherwise, without the prior written permission of Autel.

## Disclaimer of Warranties and Limitation of Liabilities

All information, specifications and illustrations in this manual are based on the latest information available at the time of printing.

Autel reserves the right to make changes at any time without notice. While information of this manual has been carefully checked for accuracy, no guarantee is given for the completeness and correctness of the contents, including but not limited to the product specifications, functions, and illustrations.

Autel will not be liable for any direct damages or for any special, incidental, or indirect damages or for any consequential economic damages.

---

## ! IMPORTANT

Before operating or maintaining this unit, please read this manual carefully, paying extra attention to the safety warnings and precautions.

---

## For Services and Support



<http://pro.autel.com>  
[www.autel.com](http://www.autel.com)



1-855-288-3587/1-855-AUTELUS (North America)  
0086-755-86147779 (China)



[Support@autel.com](mailto:Support@autel.com)

For technical assistance in all other markets, please contact your local selling agent.

# Safety Instructions

To prevent personal injury or damage to vehicles and/or the inspection tool, read this instruction manual first and observe the following safety precautions at a minimum whenever working on a vehicle.

## Work Area Safety

---

- Always perform automotive testing in a safe environment.
- Keep clothing, hair, hands, tools, test equipment, etc. away from all moving or hot engine parts. The cable shall be operated under 60 °C (140 °F).
- Operate the tool in a well-ventilated work area.
- Do not operate the tool in a potentially combustive atmosphere, such as in the presence of flammable liquids, gases, or heavy dust.
- Keep a fire extinguisher for use on gasoline/chemical/electrical fires nearby.
- Do not use the tool around corrosive chemicals.
- Keep bystanders, children and visitors away vehicle testing area.
- Keep the tool dry, clean, free from oil, water and grease. Use a mild detergent on a clean, damp cloth to clean the outside of the tool when necessary.

## Electrical Safety

---

- Keep the tool away from grounded surfaces such as pipes, radiators, ranges and refrigerators.
- Do not expose the tool to rain or wet conditions. Water entering

the tool will increase the risk of electric risk.

- Do not unplug the tool from the electrical outlet by pulling on electrical cord. Never carry tool by cord. Keep cord away from heat, oil, sharp edges or moving parts.
- If operating the tool in a damp location is unavoidable, use a ground fault circuit interrupter (GFCI) to protect the tool from damage and the operator from injury.

## **Personal Safety**

---

- Do not use the tool while tired or under the influence of drugs, alcohol, or medications. A moment of distraction can result in serious personal injury.
- Do not over-reach. Keep proper footing and balance at all times. Proper footing and balance enable better control of the tool in unexpected situations.
- Always wear safety eye protection that meets ANSI standards.
- Do not wear loose clothing or jewelry. Keep your hair, clothing, and gloves away from moving parts.
- Do not place the tool on any unstable cart or surface. The tool may fall causing serious injury to a person or serious damage to the tool itself.
- Do not have liquids near the tool. Liquid increases the risk of electric shock and damage to the tool.
- Do not use the tool for personal or medical use.
- The product is not shock-resistant. Handle it with care and be careful not to drop it.

# Contents

<b>1. USING THE MANUAL</b> .....	<b>1</b>
<b>CONVENTIONS</b> .....	<b>1</b>
<b>2. GENERAL INTRODUCTION</b> .....	<b>3</b>
<b>2.1 DESCRIPTION</b> .....	<b>3</b>
<b>2.2 SPECIFICATIONS</b> .....	<b>3</b>
<b>2.3 ACCESSORIES INCLUDED</b> .....	<b>4</b>
<b>2.4 TOOL COMPONENTS AND PORTS</b> .....	<b>5</b>
<b>2.5 BUTTONS AND CONTROLS</b> .....	<b>8</b>
<b>3. INSTALLATION AND CONNECTION</b> .....	<b>11</b>
<b>3.1 THE IMAGER HEAD AND CABLE INSTALLATION</b> .....	<b>11</b>
<b>3.2 ACCESSORIES INSTALLATION</b> .....	<b>11</b>
<b>3.3 MICRO SD CARD INSTALLATION</b> .....	<b>12</b>
<b>3.4 MINI USB CABLE CONNECTION</b> .....	<b>12</b>
<b>3.5 MICRO HDMI CABLE CONNECTION</b> .....	<b>13</b>
<b>4. BATTERY CHARGING PRECAUTIONS</b> .....	<b>14</b>
<b>4.1 BATTERY CHARGING SAFETY</b> .....	<b>14</b>
<b>4.2 BATTERY AND CHARGER SPECIFICATIONS</b> .....	<b>14</b>
<b>4.3 CHARGER INSPECTION</b> .....	<b>15</b>
<b>4.4 BATTERY CHARGING PROCEDURES</b> .....	<b>15</b>

<b>5. OPERATION INSTRUCTIONS</b> .....	17
<b>5.1 BASIC OPERATION</b> .....	17
<b>5.2 OPERATION PRECAUTIONS</b> .....	18
<b>5.3 TOOL INSPECTION</b> .....	20
<b>5.4 TOOL AND WORK AREA SET-UP</b> .....	21
<b>5.5 ON SCREEN NAVIGATION</b> .....	23
<b>5.6 SETTINGS</b> .....	32
<b>5.7 FIRMWARE UPDATE</b> .....	40
<b>6. TROUBLESHOOTING</b> .....	42
<b>7. COMPLIANCE INFORMATION</b> .....	43
<b>8. WARRANTY INFORMATION</b> .....	44
<b>8.1 LIMITED ONE YEAR WARRANTY</b> .....	44
<b>8.2 SERVICE PROCEDURES</b> .....	44

# 1. Using the Manual

This manual contains device usage instructions.

Some illustrations shown in this manual may depict tool models and/or optional equipment that are not included on or with your system. Contact your sales representative for availability of tool options or accessories not included.

## Conventions

The following conventions are used.

### Bold Text

Bold text is used to highlight selectable items such as buttons and menu options.

Example:

- Press **OK**.

### Notes and Important Messages

#### *Notes*

A **NOTE** provides helpful information such as additional explanations, tips, and comments.

Example:

---

#### **NOTE**

New batteries reach full capacity after approximately 3 to 5 charging and discharging cycles.

---

#### *Important*

**IMPORTANT** indicates a situation which, if not avoided, may result in damage to the test equipment or vehicle.

Example:

**IMPORTANT**

Keep the cable away from heat, oil, sharp edges and moving parts. Replace damaged cable immediately.

---

**Hyperlinks**

Hyperlinks or links that take you to other related articles, procedures, and illustrations are available in electronic documents. Blue italic text indicates a selectable hyperlink.

**Illustrations**

Illustrations used in this manual are samples, the actual testing screen may vary for each vehicle being tested. Observe the menu titles and on-screen instructions to make correct option selection.

## 2. General Introduction

### 2.1 Description

The MaxiVideo MV460, the next generation of digital videoscope, is ideal for inspecting difficult-to-reach areas with its semi-rigid flexible cable and 10-level adjustable LED light. It features a 1920 x 1080 high resolution camera, a 3.5-inch 640 x 480 full color LCD display, an 8.5mm camera probe, and a built-in 2600mAh battery with up to 4 hours of continuous use. This multipurpose videoscope is an economical solution to inspect machinery, facilities, and infrastructure in the safest, quickest and most cost-effective manner possible.

This manual describes the construction and operation of the device and how it works to examine difficult-to-reach areas.

### 2.2 Specifications

<b>Recommended use</b>	Indoor
<b>Optimal viewing Distance</b>	0.79" to 2" (2 cm to 5 cm)
<b>Image capture</b>	JPG images (1920 x 1080 pixels) MP4 videos (1920 x 1080 pixels)
<b>Screen type display</b>	3.5" TFT LCD
<b>Display resolution</b>	640 x 480 pixels
<b>Power supply</b>	Built-in rechargeable lithium-ion battery pack (3.7V/2600 mAh)
<b>Tested battery life</b>	Approximately 4 hours of continuous use



<b>Dimensions</b>	235 x 97 x 125mm (9.3" x 3.8" x 4.9" )
<b>Weight</b>	0.393kg (0.87lbs)
<b>Recording medium</b>	Micro SD card (8GB Standard/128GB Max)
<b>Image controls</b>	Zoom, low light vision
<b>Lighting</b>	Fully adjustable LED
<b>Cable reach</b>	1m (39.4")
<b>Imager head</b>	8.5mm (0.33"), 2 megapixel (1920 x 1080 pixels)
<b>Waterproof</b>	To a depth of 1m (39.4") (Imager heads and cable only)
<b>Additional ports</b>	TF, Mini USB, Micro HDMI
<b>Operating temp.</b>	Main unit: 14°F to 122°F (-10°C to 50°C); Cable: 14°F to 140°F (-10°C to 60°C)
<b>Storage temp.</b>	-4°F to 158°F (-20°C to 70°C)
<b>Operating humidity</b>	5% - 95% non-condensing

## 2.3 Accessories Included

- 1) User Manual
- 2) Imager Head and Cable (8.5mm)
- 3) Magnet, Hook, Mirror
- 4) Charger

- 5) Mini USB Cable
- 6) Micro SD Card
- 7) Protective Carrying Case

## 2.4 Tool Components and Ports

The MaxiVideo MV460 comes with the following items:

- 
- NOTE**  
Because of continuing improvements and modifications, actual product may differ slightly from photo.
- 

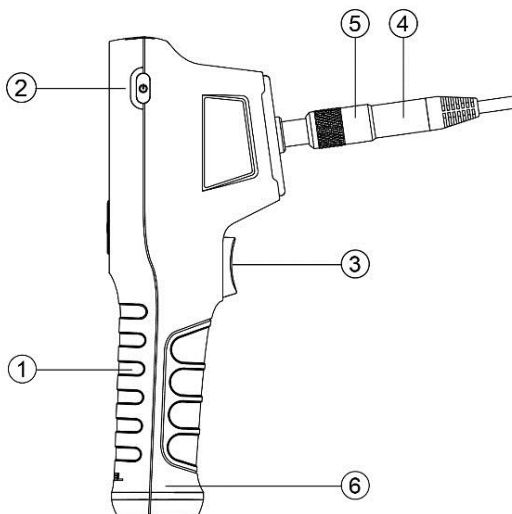

**Figure 2-1** MaxiVideo MV460 Right Side View

- 1. Handheld Display Unit – The ergonomic tool with comfortable pistol grip design.
- 2. Power Button – Powers tool on and off.

3. Shoot Button – Takes photos, starts and stops video recording. While in Settings or Galley, press to exit to live image screen.
4. Imager Head and Cable – Connects to the tool, enables the viewing of images and videos.
5. Cable Connector – Connects the display unit to the imager head and cable.
6. Battery Compartment Cap – Battery is installed under the cap.

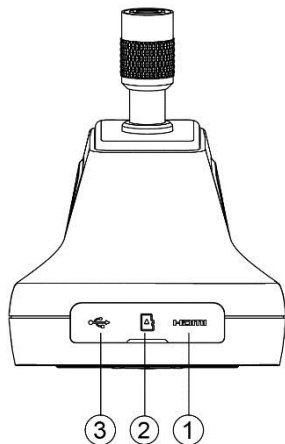

**Figure 2-2** *MaxiVideo MV460 Top View*

1. Micro HDMI Port – Enables images and videos to be displayed on a monitor. Attach a micro HDMI cable to this port and the HDMI port of a monitor to view live or recorded still and video images.
2. Micro SD card Slot – Holds the Micro SD card.
3. Mini USB/Power Source Port – Connects the tool to a computer with the supplied Mini USB cable for uploading images. Connects the tool with the supplied charger to power on the tool or to charge battery.

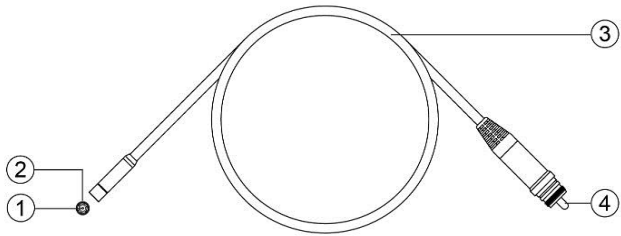

**Figure 2-3** MaxiVideo MV460 Cable and Imager Head

1. Imager Head
2. LED Light
3. Cable
4. Alignment Key

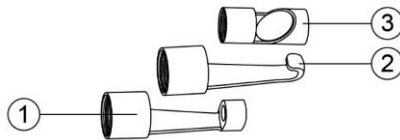

**Figure 2-4** MaxiVideo MV460 Accessories

1. Accessory Magnet – Attach to tool to pick up small metal objects such as screws.
2. Accessory Hook – Attach to tool to pick up wires or rings in pipes or confined areas.
3. Accessory Mirror – Attach to tool to inspect corners and unreachable areas.

## 2.5 Buttons and Controls

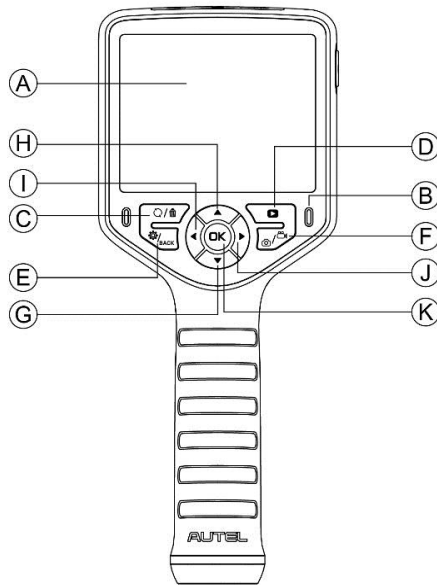

**Figure 2-5** *MaxiVideo MV460 Buttons and Controls*

- A. LCD Screen
- B. Charging Indicator Light – Lights yellow when charging and lights green when charging is complete.
- C. Trash/Reverse Button – In Play mode, press button to delete captured photos and videos. In Camera/Video mode, press button to change the orientation of still or video images. Depending on the setting, when the Reverse button is pressed, the image can be flipped (vertically or horizontally) or rotated 90 degrees.
- D. Play Button – In Play mode, press button to replay captured photos and videos. In Camera/Video mode, press Play button to switch to play mode.

- E. Setting/Back Button – Moves to the primary Settings screen in camera/video mode. Returns to the last viewed screen or cancels a selection in Settings mode and Play mode. In Play mode, press to suspend the playing of photos or videos or to exit from photo/video editing.
- F. Camera/Video Button – Switches between two modes: Camera or Video. In Play mode, press to advance cursor to editing to select, invert selection of, lock, or unlock image or video.
- G. Down Arrow, Zoom Button – Uses Down arrow button to zoom out while in Camera/Video mode. Press to navigate down menus and submenus in Settings mode. In Play mode, press to navigate photo or video thumbnails.
- H. Up Arrow, Zoom Button – In Camera/Video mode, press Up to zoom in. In Settings mode, press to navigate up menus and submenus. In Play mode, press to navigate photo or video thumbnails; or to advance the cursor to editing to select, invert selection of, lock, or unlock image or video.
- I. Left Arrow, LED Adjusting Button – In Camera/Video mode, press Left arrow button to decrease LED brightness. In Settings mode, press to advance the cursor. In Play mode, press to advance the cursor to the left; or to return to the previous photo or video; or to exit editing.
- J. Right Arrow, LED Adjusting Button – In Camera/Video mode, press Right arrow button to increase LED brightness. In Settings mode, press to advance the cursor. In Play mode, press to advance the cursor to the right; or to advance to the next photo or video; or to exit editing.
- K. OK Button – In Settings mode, press to confirm a selection or action. In Play mode, press to confirm a selection or action; to start or suspend the replaying of photos or videos. Press OK button to

freeze-frame camera stills while capturing photo; press OK button again to continue taking stills. Press OK button to freeze-frame video recording; press again to resume recording.

## 3. Installation and Connection

### 3.1 The Imager Head and Cable Installation

To use the tool, the imager head and cable must be connected to the display unit. To connect the cable to the display unit, align the key on the probe connector with slot on the coupling (Figure 3-1). Push the two ends together and, finger-tighten the collar to hold the connection firmly in place.

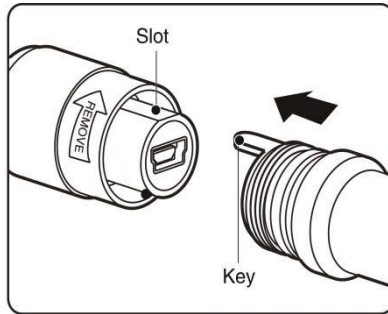

**Figure 3-1** Connect Imager with Cable

### 3.2 Accessories Installation

Three accessories are included: a magnet, a hook, and a mirror (Figure 2-4). All are attached to the imager head in the same manner. Detach the cap from the imager head as shown in Figure 3-2 and Figure 3-3. Slip the end of the accessory over the imager head and then secure the accessory as shown in Figure 3-4 and Figure 3-5.



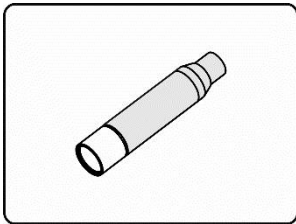

Figure 3-2

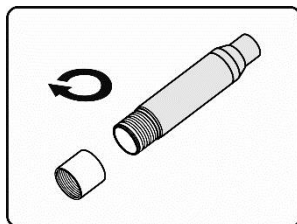

Figure 3-3

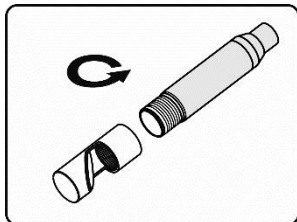

Figure 3-4

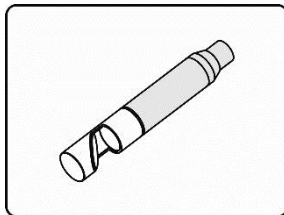

Figure 3-5

### 3.3 Micro SD Card Installation

To insert a Micro SD card into the Micro SD card slot, make sure the pins are facing towards slot and the angled portion of the card is facing down. To remove a Micro SD card, gently push the Micro SD card inward and then release to eject it from the card slot.



---

**NOTE**

A standard 8 GB Micro SD card is included to provide additional memory. The Micro SD card port supports Micro SD cards sized up to 128 GB.

---

### 3.4 Mini USB Cable Connection

Use the supplied Mini USB cable to connect the tool to a PC to charge or transfer captured photos and videos. When the tool is successfully

connected to a PC, a popup menu will display (Figure 3-6). Press Up or Down button to select Transfer Files or Charge Only.

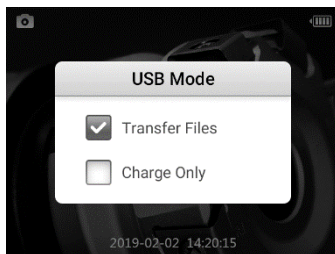

**Figure 3-6** *USB Mode*

If you select Charge Only, the tool will start charging and a battery charging icon will appear on the top right of screen. If you select Transfer Files, a USB icon will appear on the top right of the screen (Figure 3-7); you can manage and store still images and videos on the computer.



**Figure 3-7** *USB icon displays when Transfer Files selected*

## **3.5 Micro HDMI Cable Connection**

Use a micro HDMI cable (not included) to connect the tool to the HDMI port on a television or computer monitor and view real-time, high-quality images.

## 4. Battery Charging Precautions

---

### ! IMPORTANT

To reduce the risk of serious injury, read these precautions and specification label on charger carefully before using.

---

### 4.1 Battery Charging Safety

- Do not probe charger with conductive objects.
- Do not use charger if it has been dropped or damaged.
- Charge battery in temperatures above 41°F (5°C) and below 113°F (45°C).
- Keep charger out of the reach of children.
- Use only the charger supplied.
- Do not charge the battery for more than 24 hours.
- Do not cover the charger while in use.
- Do not clean charger while it is plugged into electrical outlet.
- Do not store charger in damp, wet area or with corrosive liquids.
- Do not open charger housing. Do not attempt to repair.
- Do not charge battery near fire or in the sunlight or in direct heat.
- Proper care will prevent serious damage to the charger.

### 4.2 Battery and Charger Specifications

<b>Input</b>	USB-5V
<b>Battery Type</b>	3.7V lithium-ion
<b>Battery Capacity</b>	2600mAh

<b>Input Current</b>	1A Max (USB)
<b>Charging Time</b>	3-4 hours
<b>Cooling</b>	Passive convention cooling (No fan)

## 4.3 Charger Inspection

### ! IMPORTANT

Before using, inspect the charger for any damage. Set up charger according to these procedures to reduce the risk of injury to persons and tool. Inspect the charger for damage or modifications including broken, worn, missing, misaligned or binding parts. Do not use charger if damaged.

To ensure the tool's proper operation the tool should be clean and free of oil, grease and dirt.

The warning label on charger's surface is intact and readable.

- The tool should only be charged in an appropriate workspace, with a temperature of between 41°F (5°C) and 113°F (45°C). If the temperature is out of this range at any point during charging, the operation will be suspended.
- The charger should plug correctly into the desired electrical outlet.
- The charger should have a clearance of at least 4" (10 cm) on all sides so as not to overheat.

## 4.4 Battery Charging Procedures

The tool has a 3.7V built-in rechargeable lithium-ion battery. If the battery level is too low to continue operating, the tool will automatically shut off.

There are two battery charging methods:

- 1) To charge battery by charger and Mini USB cable: Plug the supplied Mini USB cable into the tool and into the charger hub and plug the charger into the electrical outlet.
- 2) To charge battery by computer: Plug the supplied Mini USB cable into the tool and connect the cable to a USB port on a powered-on computer.
  - The battery will begin charging automatically. While the battery is charging, the charging indicator will light yellow.
  - When the battery is fully charged, the charging indicator will light green.
  - Once the battery is charged, it may remain charged until it is ready to be used. When the battery has been fully charged, the charger automatically switches to retention charging.
  - Unplug charger from outlet once charging completes.

---

🔍 **NOTE**

New battery reaches full capacity after approximately 3 to 5 charging and discharging cycles.

---

# 5 Operation Instructions

---

## ! IMPORTANT

Always wear eye protection when working on vehicles. Follow operation instructions to reduce the risk of injury.

---

## 5.1 Basic Operation

---

### 🕒 NOTE

The inspection cable is flexible and can be bent so to be used in confined spaces.

---

- 1) Hold the tool with the LCD screen facing you and press the Power button to turn on the tool. The tool will boot up, followed by the display of the Autel start-up screen and then the display of the live image.
- 2) In the Camera mode, press the **Shoot** button to capture photos. In the Video mode, press the **Shoot** button to start and stop recording videos. In the Settings or Play modes, press the **Shoot** button to exit to the live image screen.
- 3) Press **Camera/Video** button to switch between camera mode and video mode.
- 4) Press **OK** button to freeze the image in camera/video mode. Press **SHOOT** button to save the freeze frame.
- 5) Press the **UP** and **DOWN** arrow buttons to zoom in or out while in camera/video mode. The zoom indicator bar displays onscreen and adjusts to indicate magnification status.
- 6) Press **LEFT** and **RIGHT** arrow buttons to decrease or increase screen backlighting while in camera/video mode. A brightness indicator bar displays onscreen and adjusts to indicate LED intensity.

- 7) Press **Play** button to view captured photos and videos.
- 8) Press **Trash/Reverse** button to delete captured photos and videos.
- 9) Press **Trash/Reverse** button to control the orientation of the real-time image and video.
- 10) Press **Setting/Back** button to enter the settings mode or return to the previous screen.
- 11) Use the supplied accessories to provide application flexibility.
- 12) Use the supplied Mini USB cable to connect the tool to a PC to charge or to upload captured photos and videos.
- 13) Using a Micro HDMI cable, connect the tool to the HDMI port of a TV to view images and videos on a larger monitor.

## 5.2 Operation Precautions

- Use the tool only as directed. Do not operate the tool unless the user manual has been read thoroughly and proper training has been completed.
- The display unit is not waterproof. The imager head and cable are waterproof, but not acid-proof or fireproof. Do not submerge the imager head and cable in water over one meter for more than half an hour. Such measures increase the risk of electric shock and tool damage.
- Do not submerge the imager head and cable into corrosive, oily places. Keep the imager head and cable away from objects operating at a high temperature.
- Do not use excessive force to insert or withdraw the imager head and cable. This may result in damage to the tool or inspection area.

- Do not use the imager head and cable to modify surroundings, clear pathways or unclog areas.
- Do not place the imager head and cable into anything or anywhere that may contain a live electric charge or moving parts. Such actions increase the risk of electric shock or entanglement injuries.
- This is not a medical tool. Do not use the tool for personal inspection or medical use.
- Do not eat or smoke while operating the tool. If during the use of the tool, you are exposed to chemical or bacteria, use hot, soapy water to clean exposed skin.
- When the inspection is completed, carefully withdraw the imager head and cable from the inspection area.
- Maintain the tool with care. Proper maintenance of this tool is vital to its safe and effective use.
- Use care when handling this tool. Do not drop the tool, if the tool is dropped, carefully inspect this tool for breakage and any other conditions that may affect its operation.
- Only use Autel-approved accessories with this tool.
- Technicians should always operate and charge tool with dry hands.
- Always use appropriate personal protective equipment while handling and using the tool. Appropriate personal protective equipment includes safety glasses and gloves, protective clothing, respirators and steel-toed footwear.
- Protect the tool against excessive heat. The tool should be kept away from heat sources such as radiators and stoves. Do not use the tool near moving machinery or areas where the temperature exceeds 122°F (50°C).



- Store the tool, charger and all cables in a secure space.

## 5.3 Tool Inspection

---

### ! IMPORTANT

Before using this tool, inspect it for damage so as to guard against risk of electrical shock or other injury. Do not use the tool if it is damaged.

---

- Make sure the tool is powered OFF prior to cleaning.
- Clean any oil, grease or dirt from the tool, especially on the buttons and ports to help prevent the tool from slipping from your hands.
- Inspect the imager head lens for condensation. To avoid damaging the tool, do not use the tool if condensation forms inside the imager head. Let the water evaporate before using.
- Inspect the full length of the cable for cracks or damage. A damaged cable could allow water to enter the tool and increase the risk of electric shock.
- Make sure the connections between the display unit and imager head and cable are tight. All connections must be properly assembled for the cable to be waterproof.
- The tool ships with a warning label. The label should be readable and firmly attached to the tool. Do not use the tool if you receive it without the warning label.
- Turn on the power and make sure the tool setup screen displays followed by the live image screen.
- If the tool fails to work as expected after powering on, contact support. If the tool cannot be powered off and on with the power button, stop using the tool and contact support.

---

ⓘ **NOTE**

When using the tool for the following inspections, ensure the proper precautions are taken.

---

- **FOR WALLS:** For inspecting the inside of walls, be sure to shut off the circuit breaker to the building before using the tool.
- **FOR PIPES:** Do not inspect a metal pipe if you suspect the pipe might carry an electrical charge. Have a qualified electrician check the pipe before using.
- **FOR AUTOMOBILES:** Be sure the automobile is not running during inspection. Metal and liquid under the hood may be hot, use caution. Don't get oil or gasoline on the imager head.

## 5.4 Tool and Work Area Setup

---

ⓘ **IMPORTANT**

Set up the tool and work area according to these procedures to reduce the risk of injury from electrical shock, entanglement, and other dangers and to prevent tool damage.

---

- 1) Check work area for:
  - ✓ Sufficient lighting.
  - ✓ Do not work in an area with flammable sources.
  - ✓ Do not use the tool while standing in water.
- 2) Check the area and determine if MaxiVideo MV460 Digital Inspection Videoscope is the correct tool for the job.
  - ✓ Check the access points to the area.
  - ✓ Check if there is any electric power supplied to the area to be inspected.
  - ✓ Check if any liquids will be encountered during the

inspection. The Imager head and cable are waterproof to a depth of 1m (39.4’’). Do not use in greater depths as pressure may cause the image header and the cable to become damaged risking electrical shock to user. The display unit is not waterproof and should not be exposed to wet conditions.

- ✓ Especially if using the tool in drains, ensure no chemicals have been used as caustic chemicals may damage the tool.
  - ✓ The tool should not be used in an area that is excessively hot (above 122 degrees Fahrenheit) or cold (below 14 degrees Fahrenheit).
  - ✓ Do not use the tool around or in system with moving parts.
- 3) Ensure the correct accessory is used for the appropriate application.

---

**! IMPORTANT**

**CAUTION:**

**Make sure the tool has been powered off before cleaning tool.**

---

- Tool maintenance should only be performed by qualified repair personnel. Maintenance performed by unqualified repair personnel could cause injury.
- Use only replacement parts authorized to be used with or on product. Only perform the maintenance instructions described. Unauthorized maintenance may create a risk of electric shock or injury.
- Follow instructions to change accessories.
- Clean the tool with alcohol only. Swab the connections carefully. Do not use acetone. Do not use excessive pressure when cleaning the LCD screen. After each use, use a dry cloth to gently wipe

the display unit.

- Only qualified repair personnel should repair this tool and perform a safety check of the tool prior to use.
- Stop using the tool if it emits smoke or a burning odor.
- Use care when handling the tool; The tool is not shock resistant.
- Do not disassemble the tool beyond what is shown in the manual.
- Disassembling the tool will void the warranty.

## 5.5 On Screen Navigation

### 1) Start-up Screen

When the tool is powered on, the start-up screen will display depicting the Autel logo (Figure 5-1). Next, the tool will display a live camera mode.



**Figure 5-1** *Start-up Screen*

### 2) Live Screen

The live screen is where you will do most of your work. A live view of what the imager head sees is displayed on the screen. Zoom, adjust lighting, freeze-frame camera or video recording, reverse/rotate photos and videos, and capture photos and videos from this screen.



**Figure 5-2** Live Screen image, example

### 3) Switching from Camera to Video Mode

The tool's default mode is the Camera Mode. Press **Camera/Video** button to switch between Camera and Video mode.

### 4) Capturing Photo

When in the live screen, make sure the camera icon is displayed on the top left of the screen (Figure 5-3). Press the **Shoot** button to take a still image. The still image will automatically be saved to the Micro SD card.



**Figure 5-3** Still Image, example

### 5) Record Video

To record video, ensure the video icon is displayed on the top left of the screen (Figure 5-4). Press the **Shoot** button to start recording; The

red REC icon will display within the video icon. The time length of the recording will display below the REC icon. Press the **Shoot** button again to stop recording, and the video will automatically be saved to the Micro SD card.



**Figure 5-4** Video Recording, example screen

Video recording cannot be performed when the battery falls below eight percent (Figure 5-5). Please charge prior to recording.

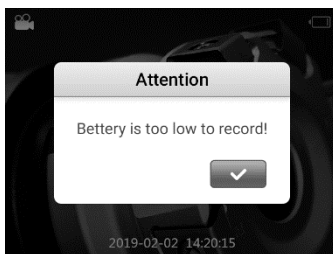

**Figure 5-5** Battery is too low to record, example screen

## 6) Adjusting LED Brightness

Press **RIGHT** or **LEFT** arrow buttons to increase or decrease the LED brightness; Press and hold the buttons to adjust brightness quickly and continuously. A brightness indicator bar will display on the screen as the LED is adjusted (Figure 5-6).

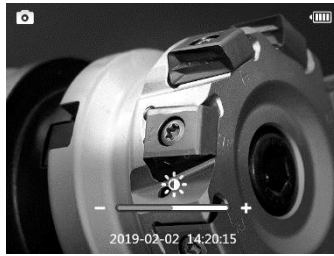

**Figure 5-6** *Adjusting LED Brightness, example screen*

## 7) **Zooming**

Press **UP** or **DOWN** arrow buttons to zoom in or zoom out; Press and hold the buttons to zoom quickly and continuously. A zoom indicator icon will display on the screen as zoom is adjusted (Figure 5-7).



**Figure 5-7** *Adjusting Zoom, example screen*

## 8) **Reverse/Rotate**

Press the **Reverse/Rotate** button to control the orientation of the real-time image and video on the live screen. A rotate/reverse indicator icon will display on the screen as the image is adjusted (Figure 5-8). By default, when the Reverse/Rotate button is pressed, the live image or video will flip horizontally or vertically. Change the function of the button to rotate the image 90 degrees clockwise in Settings.

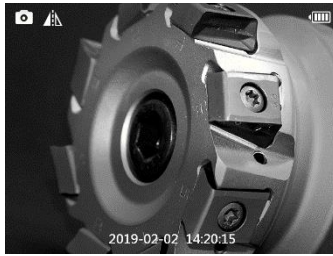

**Figure 5-8** Reverse Button adjusted image, example screen

## 9) Freeze Frame

In the camera/video mode, press the **OK** button to freeze the still camera or video recording (Figure 5-9). Press the **OK** button to freeze-frame still camera image; press the button again to resume image capturing. Press the **OK** button to freeze-frame during video recording, and the freeze frame image is saved to the Video folder. Press the **OK** button again to resume recording.

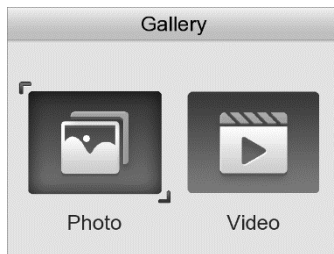

**Figure 5-9** Freeze-Frame, example screen

## 10) Playback and Delete Saved Photos and Videos

Press **PLAY** button while in camera/video mode and the captured photo or video will display on the screen (Figure 5-10). Captured photos and videos will be saved in the Gallery's Photo or Video folders, respectively.





**Figure 5-10** *Image Gallery: Photo & Video*

Press **LEFT/RIGHT** button to select Photo or Video folder. Press the **OK** button to confirm. The stored photos and videos display as thumbnails (Figure 5-11).

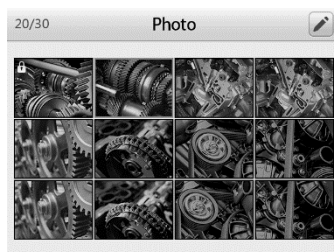
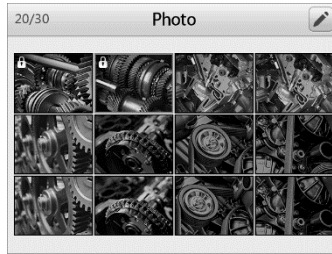

**Figure 5-11** *Photo Gallery, example screen*

Press and hold **UP/DOWN** button or **LEFT/RIGHT** button to quickly and automatically advance the cursor to navigate photo or video thumbnails.

## 11) **Preview Mode**

A lock icon will display atop the thumbnail image to indicate the file cannot be deleted (Figure 5-12). A play button icon displays for a video file (Figure 5-13).



**Figure 5-12** *Photo Gallery Preview Mode, example screen*



**Figure 5-13** *Video Gallery Preview Mode, example screen*

## 12) Editing Mode

Move the cursor to the first row of photos or videos files, press the **UP** button to access the Pen icon on the top right of the screen. Press the **OK** button to enter file editing. Or, press **Camera/Video** button in preview mode to directly enter editing mode. Select, reverse select, lock, and unlock files in editing mode (Figure 5-14). A checkmark will display in the lower right-hand corner of selected files.

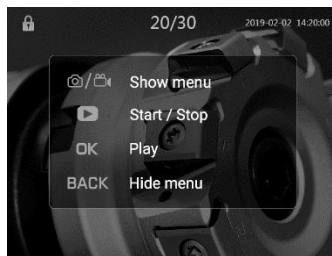

**Figure 5-14** *Editing Mode, example screen*

Press the **LEFT/RIGHT** or the **UP/DOWN** button to select editing function and the file to edit. Press the **DELETE** button to delete selected files. Batch editing, whereby multiple files can be selected and edited is allowed in editing mode.

### 13) Play Mode

In the thumbnail gallery, press the **OK** button to select a photo or video to play. Press the **UP** button and a popup menu will display with the functions of each button defined (Figure 5-15). Press the **BACK** button and the menu will disappear.



**Figure 5-15** *Video function menu*

The numbers on the top center of the screen displays the sequence number of the playing file out of the total number of files in the folder.

Press the **LEFT** button to play the previous file or Press the **RIGHT** button to advance to the next file. Press and hold **LEFT/RIGHT** button to quickly move to the previous or next files.

Press the **DOWN** button or **CAMERA/VIDEO** button to select the lock icon, then press the **OK** button to trigger the function. Press the **BACK** button or the **LEFT/RIGHT** button and the cursor will no longer display.

Replay Video:

Without a function icon selected, press the **OK** button or the **PLAY** button to play the video. While a video is playing, press the **OK** button or the **BACK** button to pause the file. Press the **OK** button or press the **PLAY** button again to resume play or Press the **BACK** button to Stop playback and return to video gallery.

Delete Photo or Image:

While reviewing a photo or video, press **TRASH** button to delete the file. A message will display asking to confirm deletion (Figure 5-16).

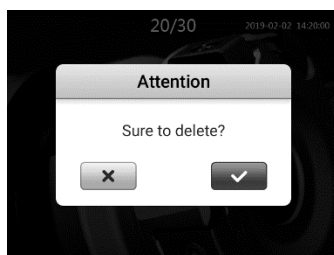

**Figure 5-16** Delete Image Confirmation Window

Select the onscreen checkbox button and press the **OK** button to delete the file or select the “X” button and press **OK** button to cancel

delete. Or, press the **BACK** button to cancel delete.









---

 **NOTE**

Locked files cannot be deleted.

---

## Icons

- 1)  **Battery Capacity** – Fully charged battery.
- 2)  **No SD card** – No Micro SD card is present in the tool. When the tool is connected to a PC, the Micro SD card will eject automatically and the icon will display.
- 3)  **USB** – The tool is connected to a PC via a Mini USB.
- 4)  **Hold** – Image is paused or held in freeze frame.
- 5)  **Still Camera** – Operating in still camera mode.
- 6)  **Video Camera** – Operating in video camera mode.
- 7)  **Reverse** – Image/video is reverse or flipped in camera/video mode.
- 8)  **x7 Zoom** – Displays zoom magnification rate in camera/video mode.

## 5.6 Settings

Press **SETTING** button while on the live image screen to access the primary settings screen menu (Figure 5-17), to view the MV460 videoscope tool information and change the default settings. There are five settings in the menu. Press the **BACK** button or the **SHOOT** button to exit to the live image screen.

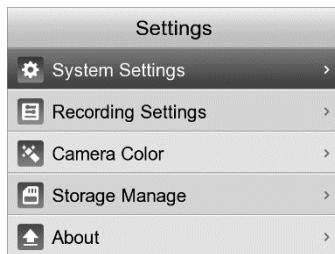

**Figure 5-17** Primary Settings Menu

## 1) System Settings Screen

From the primary settings screen, select **System Settings** and press the **OK** button. In System Settings (Figure 5-18), set **Language**, **Date and Time**, **Help Tip**, **Auto Poweroff**, and **Factory Reset** as needed. Press the **BACK** button once to exit to the primary settings menu. Double-Press the **Back** button to exit to the Live Image screen. Press the **Shoot** button at any time to return to the Live Image screen.



**Figure 5-18** System Settings menu

- Language

Change the MV460's operating language from English (default) to any of the displayed languages (Figure 5-19). In the **System Settings** screen, select **Language** and press the **OK** button. A list of available system languages will display. There are 13 languages available.

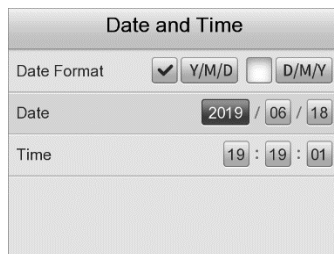

**Figure 5-19** *Language Setting menu*

Use the **UP/DOWN** button to move to the desired language, press the **OK** button to confirm and exit, or press the **Back** button to cancel. English is the default language.

- **Date and Time**

Adjust the date and time for the MV460 system. In the **System Settings** screen, select **Date and Time** and press the **OK** button. The Date and Time settings screen will display (Figure 5-20).



**Figure 5-20** *Date and Time Setting Screen*

**Date Format:** The Date can be displayed in two formats. Choose between displaying (Y)ear/(M)onth/(D)ate or (D)ate/(M)onth/(Y)ear. Use the **LEFT/RIGHT** button to select format. A Check Mark will display in the selected format. After selecting Date Format, set the date by using the **RIGHT** button to navigate to Year or Date setting

(depending on chosen format); Press and hold the **LEFT/RIGHT** button to quickly and automatically navigate. Press the **UP/DOWN** button to increase or decrease the number; Press and hold the button to quickly and automatically adjust. The remainder of the date can be set in the same manner. The time (military time) is set in the same manner. When the date format, date and time is set, press the **OK** button to confirm and exit. Or, Press the **BACK** button to exit to the previous screen or press the **SHOOT** button to exit to the Live Image Screen without saving changes.

- **Help Tip**

Enable or disable Help Tip. In the **System Settings** screen, select **Help Tip**, and press the **OK** button. Use the **LEFT/RIGHT** button to enable or disable Help Tip.

- **Auto Poweroff**

Set Auto Power-off to schedule the tool to power-off after the set amount of tool inactivity. In the **System Settings** screen, select **Auto Power-off** and press the **OK** button, then the Auto Power-off settings screen will display (Figure 5-21). Use the **UP/DOWN** button to select one of the four choices: Disable, 3 minutes, 10 minutes, and 30 minutes. Press the **OK** button to confirm and exit. Or, Press the **BACK** button to exit to the previous screen or press the **SHOOT** button to exit to the Live Image Screen without saving changes.



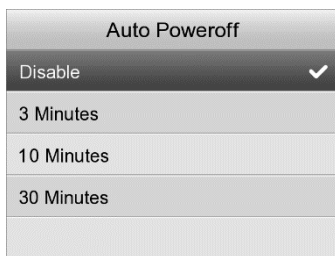

**Figure 5-21** *Auto Power-off Setting Screen*

- **Factory Reset**

Reset the tool to its factory settings. System and Recording settings will be reset to default settings. In the **System Settings** screen, select **Factory Reset** and press the **OK** button. A reset confirmation dialog window will display (Figure 5-22). Use the **LEFT/RIGHT** button to select the checkbox and press the **OK** button to reset the tool or select the “X” box and press the **OK** button to cancel the reset and return to the system settings menu or press the **Back** button to cancel and exit.



**Figure 5-22** *Factory Reset*

---

① **NOTE**

Factory Reset will reset all settings and erase all user-added content. Back up Micro-SD card data to a computer to save still and video images.

---

## 2) Recording Settings

From the Primary Settings Screen, select **Recording Settings** and press the **OK** button (Figure 5-23) to set **Rotation Mode** and **Time Stamp** as needed. Press the **BACK** button to return to the primary settings screen. Press the **BACK** button twice to return to Live Image screen. Press the **SHOOT** button at any time to return to the Live Image screen.

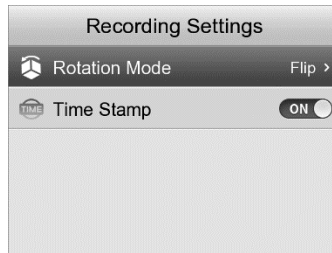

**Figure 5-23** *Recording Settings, example screen*

- **Rotation Mode**

Select the action of the Rotation button. When selected, the Live Image can be Flipped or Rotated, depending on the setting. On the **Recording Settings** screen, select **Rotation Mode** and press the **OK** button. The rotation mode settings screen will display (Figure 5-24). Use the **UP** or **DOWN** buttons to select Flip or Rotate image options. Once selection is made, press the **OK** button to confirm, or press the **Back** button to exit without saving changes.

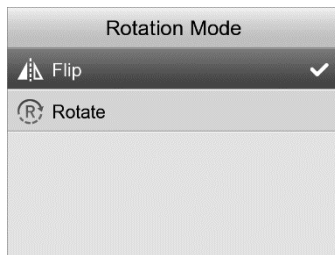

**Figure 5-24** *Rotation Mode Setting*

- Time Stamp

Adds time stamp to recorded photo or video. In the **Recording Settings** screen, select **Time Stamp** and press the **OK** button or press the **LEFT** or **RIGHT** button to enable/disable time stamp.

### 3) Camera Color

Choose between Color and Monochrome camera color for the cable's camera. In the **Settings** screen, select **Camera Color** and press the **OK** button. The default mode is Color (Figure 5-25). Select Monochrome to display the image in the Monochrome.



**Figure 5-25** *Camera Color settings menu*

Use the **UP/DOWN** button to select mode. Press the **OK** button to save the selection and exit, or press the **Back** button to exit without

saving settings change.

#### 4) Storage Manage

Select Storage Manage to view the used and the remaining space on the micro-SD card and the number of video and image files saved on the card. The micro-SD card can also be formatted from this screen. From the primary settings menu, select **Storage Manage** and press the **OK** button. (Figure 5-26).

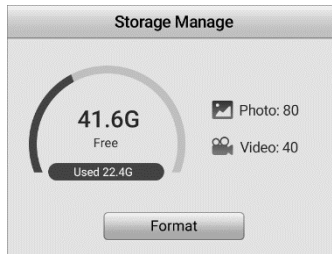

**Figure 5-26** *Storage Manage, example screen*

Press the **UP/DOWN** or the **LEFT/RIGHT** button to select **Format**. Press the **OK** button to confirm. A message will display warning that all files will be deleted if Format is selected (Figure 5-27). Select the checkbox to delete or select the “X” box to cancel format and exit. When formatting is completed, press the **OK** or the **BACK** button to exit. Please note, the files on the SD card cannot be restored after formatting.



**Figure 5-27** *Format Warning screen*

- 
- ① **NOTE**  
Formatting Micro-SD card will erase all contents. Ensure all videos and still images that are wanted are saved to a computer.
- 

## 5) About

Screen displays current firmware version and Update button for firmware update. From the **Settings** screen, select **About** and press the **OK** button. The firmware version screen will display. Press **UP/DOWN** or **LEFT/RIGHT** button to select the Update button. Press **OK** button to initiate update.



**Figure 5-28** *About Screen, example*

- 
- ① **NOTE**  
When the tool is charging, update can only be performed with a battery level of above 10 percent. When the tool is not charging, update can only be performed with a battery level of above 25 percent.
- 

## 5.7 Firmware Update

- 
- ① **NOTE**  
Software updates, when available, are available to be downloaded free for the life of the tool.
-

- 1) Connect your Micro SD card to a computer.
- 2) Visit our website [www.autel.com](http://www.autel.com) and download firmware update file to your Micro SD card.
- 3) Insert your Micro SD card into the Micro SD card slot.
- 4) Press **SETTING** button, then select **About**. Press **OK** button to enter About, select **Update** to upgrade the tool (Figure 5-29).

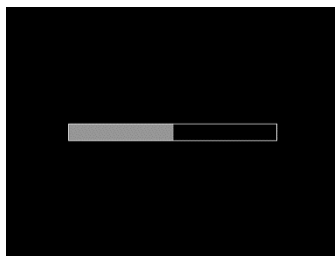

**Figure 5-29** *Firmware Update screen*

# 6 Troubleshooting

Table 6-1 Troubleshooting

Symptoms	Possible Cause	Solutions
Display is on, but does not show image.	Cable connection is loose.	Check and reattach.
	Imager head is covered.	Ensure the imager head is not covered.
LED on imager heads are dim at max brightness, display changes between monochrome and color mode, and then turns itself OFF after a short period.	Low battery.	Charge battery.
The tool cannot turn on.	Battery is Dead.	Charge battery.

# 7 Compliance Information

## FCC COMPLIANCE

MV460 complies with Part 15 of the FCC Rules and with RSS of Industry Canada. Operation is subject to the following two conditions:

1. This device may not cause harmful interference.
2. This device must accept any interference received, including interference that may cause undesired operation.

Cet appareil est conforme aux CNR exempts de licence d'Industrie Canada. Son fonctionnement est soumis aux deux conditions suivantes:

1. Ce dispositif ne peut causer des interférences; et
2. Ce dispositif doit accepter toute interférence, y compris les interférences qui peuvent causer un mauvais fonctionnement de l'appareil.

---

### WARNING

Changes or modifications not expressly approved by the party responsible for compliance could void the user's authority to operate the equipment.

---

### NOTE

This equipment has been tested and found to comply with the limits for a Class B digital device, pursuant to Part 15 of the FCC Rules. These limits are designed to provide reasonable protection against harmful interference in a residential installation.

---

## RoHS COMPLIANCE

This device is declared to be in compliance with the European RoHS Directive 2011/65/EU.

## CE COMPLIANCE

This device is declared to conform to the essential requirements of the following Directives and carries the CE mark accordingly:

EMC Directive 2014/30/EU

RE Directive 2014/53/EU

Low Voltage Directive 2014/35/EU



## **8 Warranty Information**

### **8.1 Limited One Year Warranty**

Autel warrants to its customers that this product will be free from all defects in materials and workmanship for a period of one (1) year from the date of the original purchase, subject to the following terms and conditions:

- 1) The sole responsibility of Autel under the Warranty is limited to either the repair or, at the option of Autel, replacement of the tool at no charge with Proof of Purchase. The sales receipt may be used for this purpose.
- 2) This warranty does not apply to damages caused by improper use, accident, flood, lightning, or if the product was altered or repaired by anyone other than the Manufacturer's Service Center.
- 3) Autel shall not be liable for any incidental or consequential damages arising from the use, misuse, or mounting of the tool.
- 4) All information in this manual is based on the latest information available at the time of publication and no warranty can be made for its accuracy or completeness. Autel reserves the right to make changes at any time without notice.

### **8.2 Service Procedures**

If you have any questions, please contact your local store, distributor or visit our website at [www.autel.com](http://www.autel.com).

If it becomes necessary to return the tool for repair, contact your local distributor for more information.