

AUTEL

MAXISYS™

ADAS

ADVANCED DRIVER ASSISTANCE SYSTEM

**CALIBRATION
TOOL PACKAGE**

ADJUSTABLE CALIBRATION FRAME

Ideal for collision repair, glass replacement and repair shop use.
Calibration for camera, radar, lidar and night vision based systems.



Frequently update MaxSys software to provide newest model OE level coverage.



OE level calibration with graphic instruction is easier to use than OE interface.

FLEXIBLE | PRECISE | COMPLETE

Easily Interchangeable Calibration Components with Power Adjustable Frame

Secure Knob Movement with Laser Positioning for Accuracy of Millimeter Ruler

Exceptional Vehicle Coverage and Graphic Instruction for Accurate Calibration Procedures



WWW.AUTEL.COM

ADAS CALIBRATION TOOLS PATENT PENDING



ADAS FRAME

ADJUSTABLE CALIBRATION SYSTEM

- The Standard package calibration frame includes all parts shown, to provide the modular tool setup needed to complete standard ADAS calibrations.
- Easily adjustable calibration frame to ensure vehicle is correctly positioned then assemble interchangeable targets to perform accurate calibrations.

Calibration Frame Standard Package

VW-LDW (CSC0601/01) INCLUDED PATTERNS Mercedes-LDW (CSC0601/02)

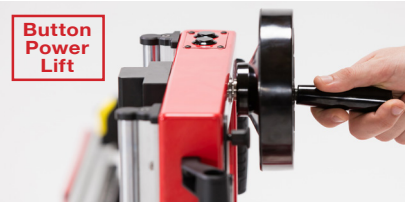
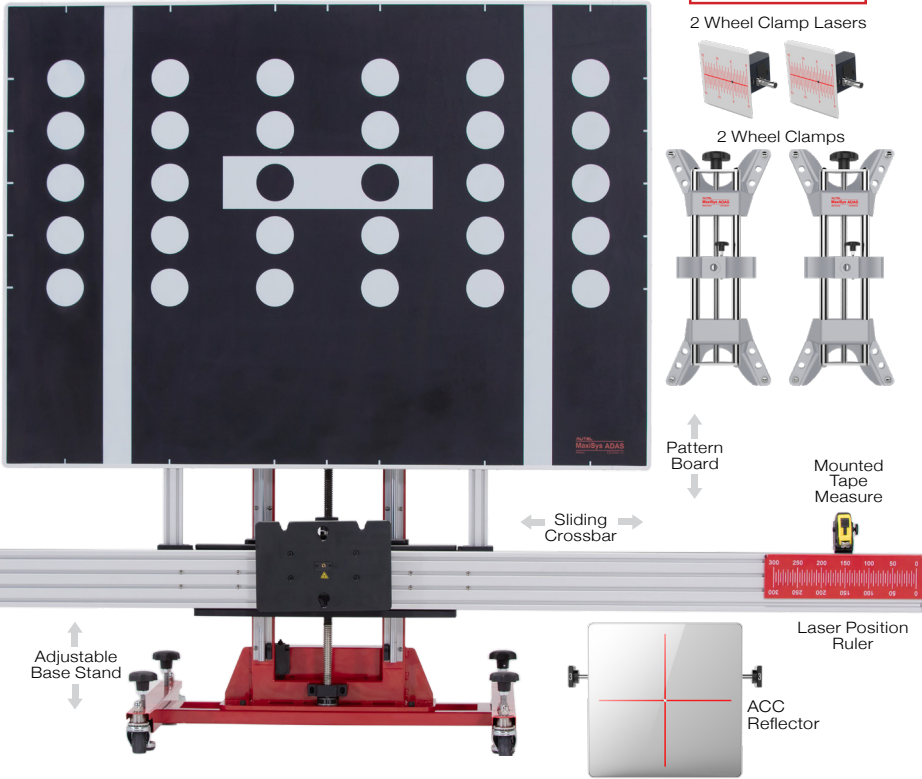

Move securely by wheels and pulleys to level for calibration.

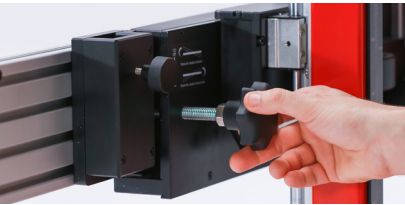

Adjust crossbar height, left-right movement at precise angles.



Reach millimeter accuracy by rulers and laser positioning.

ADAS SOFTWARE

PRECISE CALIBRATION PROCEDURES

- Autel engineers ensure weekly software updates are available, to provide the newest OE level diagnostics to cover new market developments.
- The MaxiSYS software provides OE level coverage by offering graphic instruction and precise measurements for setup and calibration procedures.



- J2534 Maxiflash Elite for OE Level programming
- Faster 1.3GHz + 1.7GHz hexa-core processor
- AutoVIN / AutoSCAN all modules in all systems

TURN YOUR EXISTING MAXISYS 908 TABLET INTO AN ADAS TABLET

ADAS CALIBRATION APPLICATION



ADAS Calibration Application NOT active if MaxiSYS software updates are expired
Active MaxiSYS Updates Required Purchase TCP Subscription For Software
CALIBRATION FRAME SERIAL NUMBER IS REGISTERED TO ADAS TABLET
THE AUTEL CALIBRATION FRAME MUST BE PURCHASED TO USE SOFTWARE UPGRADE

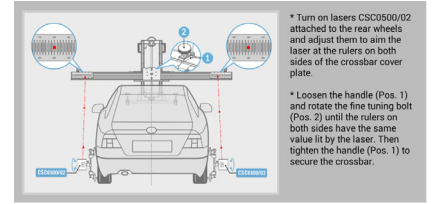

Easy to follow tutorial graphics and step by step instructions.

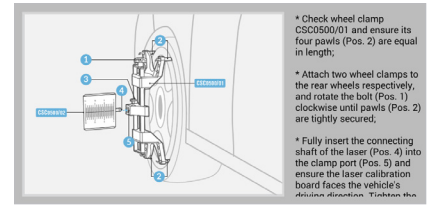

User friendly Android software with easy to use instruction navigation.

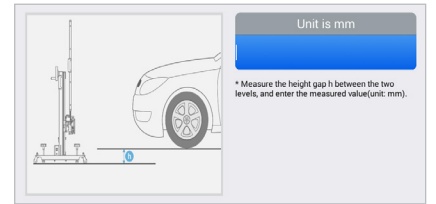

Accurate procedure descriptions for alignment lift use instructions.

MULTIPLE SYSTEM FUNCTIONS

After common repair procedures like bumper or windshield replacement, all sensor systems should be re-calibrated or this collaborative network will fail to operate correctly.

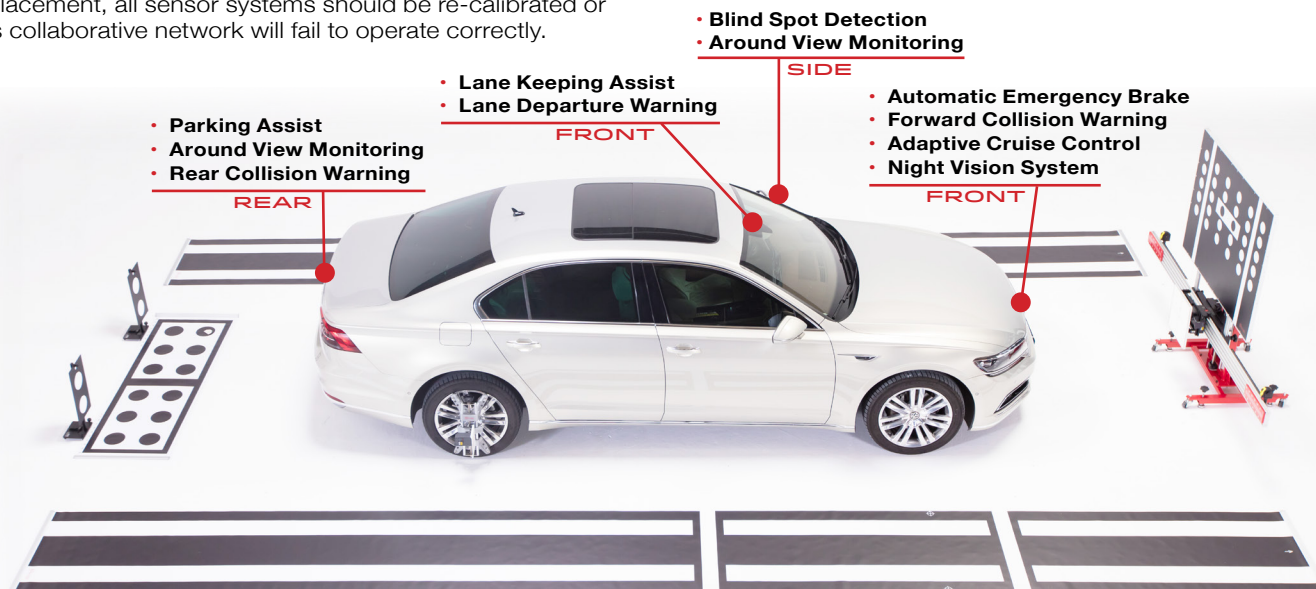

POWERFUL MAXISYS DIAGNOSTICS

ALL SYSTEMS DIAGNOSTICS
ADVANCED SERVICE FEATURES
BI-DIRECTIONAL CODING



ADAS COVERAGE

COMPREHENSIVE & PRECISE CALIBRATION

- When sensing a potentially dangerous situation, the vehicle uses several driver assist systems to warn the driver or take corrective action to prevent collision.
- Vehicles respond with passive warnings or active assists through a collaborative system of sensor input and reactive processing to respond to road hazards.

	PASSIVE FEATURE ALERT FOR POTENTIAL PROBLEM	ACTIVE FEATURE AVOID COLLISION BY CONTROL
LDW	LANE DEPARTURE WARNING	LANE KEEPING ASSIST
ACC	ADAPTIVE CRUISE CONTROL	COLLISION AVOIDANCE SYSTEM
RCW	REAR COLLISION WARNING	PARKING ASSIST
BSD	BLIND SPOT DETECTION	BLIND SPOT INTERVENTION
AVM	AROUND VIEW MONITORING	AUTOMATIC PARKING
NVS	NIGHT VISION SYSTEM	NIGHT VISION ASSIST
HUD	HEAD-UP DISPLAY	ATTENTION ASSIST

LDW PACKAGE SET

Glass Replacement shop package set of all LDW calibration patterns and targets needed for windshield replacement. Includes a target board holder for targets.



Mercedes-LDW (CSC0601/02)	Honda-LDW (CSC0601/08-L) Honda-LDW (CSC0601/08-R)	Honda-LDW (CSC0601/05)	Hyundai / KIA-LDW (CSC0601/09)
Nissan-LDW (CSC0601/03-L) Nissan-LDW (CSC0601/03-R)	Nissan / Infiniti-LDW (CSC0601/06-L) Nissan / Infiniti-LDW (CSC0601/06-R)	Toyota / Lexus-LDW (CSC0601/11)	Toyota-LDW (CSC0601/15)

ADAS CALIBRATION

AVM & REAR CAMERA PACKAGE SETS

Vehicle Coverage Added Regularly

- The Around View Monitoring pattern package sets are grouped into vehicle manufacturer regions for repair shops to order the wide range of targets for vehicles they normally repair.
- The package sets provide all the 360 Camera and Rear Camera patterns, come in durable containers for secure storage, are made of durable stain resistant material and easily cleaned.

AMERICAN

GM / CHEVY / CADILLAC / BUICK
JEEP / CHRYSLER / DODGE
FORD / LINCOLN

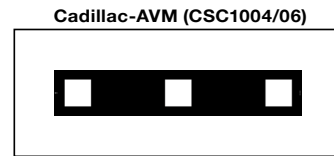

ASIAN

NISSAN / ACURA / HONDA
TOYOTA / LEXUS / INFINITI / KIA
MAZDA / HYUNDAI / SUBARU

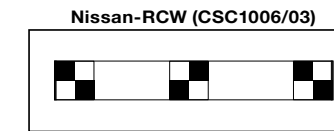
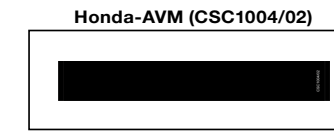
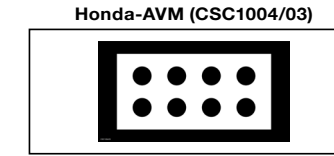

EUROPEAN

BENZ / PORSCHE / AUDI / VW
BMW / MINI / FIAT
VOLVO / JAGUAR / MASERATI

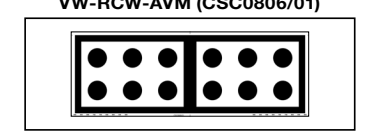
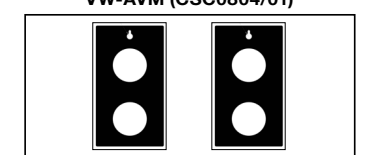
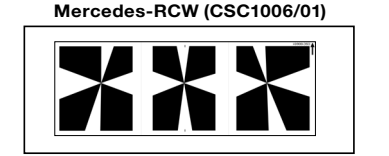

Purchase Separately - OVERSIZE AVM PATTERNS

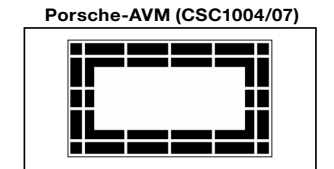
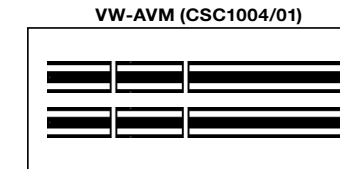
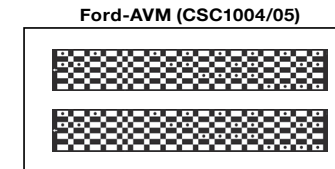

ACCESSORY CALIBRATION TOOLS

These accessory tool packages provide shops the complete set of necessary parts to perform precise calibrations on a wider range of other than camera based driver assist systems.

NIGHT VISION CALIBRATION

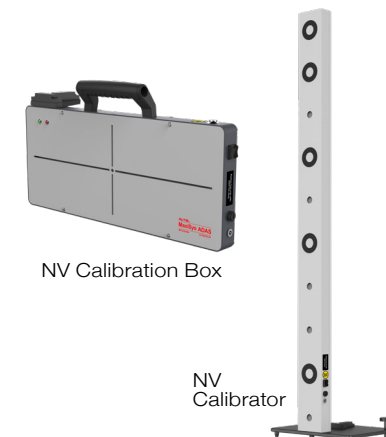

RADAR CALIBRATION



LASER CENTER AXIS



ADAS PACKAGES

READY FOR ADAS CALIBRATION?

- Frame packages do not include software to perform ADAS Calibration.
- Must order MaxiSYS ADAS Tablet or software upgrade separately.

ADAS Calibration Tablet Package

MaxiSYS ADAS Calibration Tablet - Part #MSADAS



*TURN YOUR EXISTING MAXISYS 908 TABLET INTO AN ADAS TABLET

ADAS Calibration Application Upgrade

MaxiSYS Calibration Software Upgrade - Part #ADASUPGRADE



- Active MaxiSYS Software Updates Required
- Purchase TCP Subscription For Software

ADAS Calibration Application NOT active if MaxiSYS software updates are expired

OR

2 INCLUDED PATTERNS

VW-LDW CSC0601/01 Mercedes-LDW CSC0601/02

Frame Standard Package
Adjustable Calibration Frame - Part #ADASFRAMESP

LDW Calibration Package Includes Calibration Frame Package
Lane Departure Warning Targets - Part #LDWPACKAGE

Complete Calibration Package Includes Calibration Frame Package + LDW Calibration Package

AMERICAN

Cadillac-AVM CSC1004/06

ASIAN

Honda-AVM CSC1004/02 Honda-AVM CSC1004/03

Nissan-RCW CSC1006/03

EUROPEAN

Mercedes-RCW CSC1006/01 VW-AVM CSC0804/01

VW-RCW CSC0806/01

RADAR

Radar Calibration Plate 0602/02 Radar Calibration Box 0605/01 Corner Reflector 0802/01

NIGHT VISION

Night Vision Calibration Box 0603/01 Night Vision Calibrator 0803/01

Center Axis Laser 0500/04
AVM - LDW - RCW

UNIT INCLUDED FOR CALIBRATION FRAME MOUNTING

AVM - RCW - BSD - NV Calibration - Part #ADASCOMPLETE SEPARATE PURCHASE (OVERSIZE AVM PATTERNS) • Ford-AVM (CSC1004/05) • VW-AVM (CSC1004/01) • Porsche-AVM (CSC1004/07)

ADAS SERVICE FAQ

EXPAND YOUR SHOP SERVICE OFFERINGS

- Which vehicle actions require ADAS system diagnostics or ADAS sensor calibration?**
Sensor Replacement / Accident Repair / Wheel Alignment / Windshield Replacement / Diagnostic Service
- What is the easiest way to check the vehicle to confirm which ADAS modules are active?**
a. During the Pre-SCAN procedure, the MaxiSYS software will scan all modules in all systems and list on a single screen, then provide visual ADAS icons next to the active ADAS modules. This shows technicians which ADAS systems are active and helps prepare a more detailed repair plan which includes the required ADAS calibration procedures after the repairs are complete.
- How do I know what patterns and calibration procedures to use?**
a. The Autel MaxiSYS ADAS Calibration Application software provides graphic step-by-step instructions that are vehicle model specific to confirm the correct patterns are used during the correct calibration procedures. Your MaxiSYS software confirms this information is correct, based on the vehicle information confirmed from the AutoSCAN feature, to confirm which active ADAS modules in any vehicle system may need a calibration procedure completed.
- How do I know if the ADAS recalibration was successful?**
a. The technician can review the post-calibration scan to confirm if the module DTC is cleared. The ADAS module calibration will not complete if the calibration steps were not followed correctly.
- What vehicle preparation is required before performing calibration procedures?**
 - The vehicle coolants and engine oil should be at recommended levels and the gas tank full.
 - The vehicle should not be carrying any load (passengers or cargo).
 - Adjust the tire pressure to the recommended value.
 - Attach the wireless VCI to the vehicle DLC.
 - Make sure the MaxiSYS is paired to the VCI, then make sure to close all the vehicle doors.
 - Establish communication from the diagnostic tool to the vehicle.
 - Follow the MaxiSys ADAS software instructions. Accurate preparation measures vary by vehicle and system.
- Do I need someone to assemble and or set up the calibration frame?**
a. No, the complete assembly is a simple 20-25 minute process. Graphic instruction and standard screws are included.
- Are training options necessary for working on ADAS calibrations?**
a. No, The MSADAS software features step by step illustrated instructions for placing the calibration frame and targets.
b. If a customer requests general ADAS training, I-CAR, CTI, and AutoTech have ADAS classes utilizing the Autel tool.
- If I want to add individual targets or calibration tools later, are they available for purchase?**
a. Yes, the specialty fixtures, existing targets and new vehicle coverage targets are available for individual purchase.
- Depending on which vehicle systems I am concerned with, which ADAS calibration kit should I purchase?**
 - LDW, LKA, ACC (forward looking only) - You need the LDW kit (ADS-LDWPACKAGE)
 - AVM, RCW, RCA (around view / 360 view / rear looking) - You need the Complete Kit (ADS-ADASCOMPLETE)
 - Night Vision, Radar (includes Blind Spot etc.) - Also in the Complete Kit (ADS-ADASCOMPLETE)
*can be added as additional accessories to the LDW kit
- What are the different types of ADAS calibrations and are they brand specific?**
Depending on vehicle type, either a Stationary or Dynamic calibration procedure is required (in some vehicle types both are required) to calibrate ADAS sensors to vehicle modules.
 - Stationary calibrations are completed in a shop environment and requires the use of targets or patterns to complete.
 - Dynamic calibrations require the vehicle be driven on a road with well maintained markings for a determined time.

CALCULATE SERVICE PROFITS

Driver Assist Systems are active on 2015 vehicle models and newer.
Awareness of OE specified repair and calibration requirements rests on the repairer.

COST / COMPENSATION / CYCLE TIME



	DEALER	MOBILE	REMOTE	IN-SHOP TOOL
COST TO SHOP	\$275	\$200	\$150	---
INSURER COST	\$300	\$300	\$300	\$300
CYCLE TIME	2 DAYS	1 DAY	2 HOURS	1/2 HOUR

- What are insurance companies paying for calibrations?**
 - Insurance companies are typically paying between \$200 and \$300 for each ADAS calibration.
 - The ADAS application also provides the Pre and Post-SCAN features, which insurance companies pay \$100-\$150 for.

ADAS WORKING AREA

CALIBRATION SHOP REQUIREMENTS

- Perform Calibration Procedures Indoors Without Object Obstructions
- No Exterior Light Sources To Cast Uneven Surface Shadows
- Some Procedures Require Bright Background Light Alignments

-  CLEAR & LEVEL SURROUNDING
-  BAY SIZE AREA REQUIREMENT

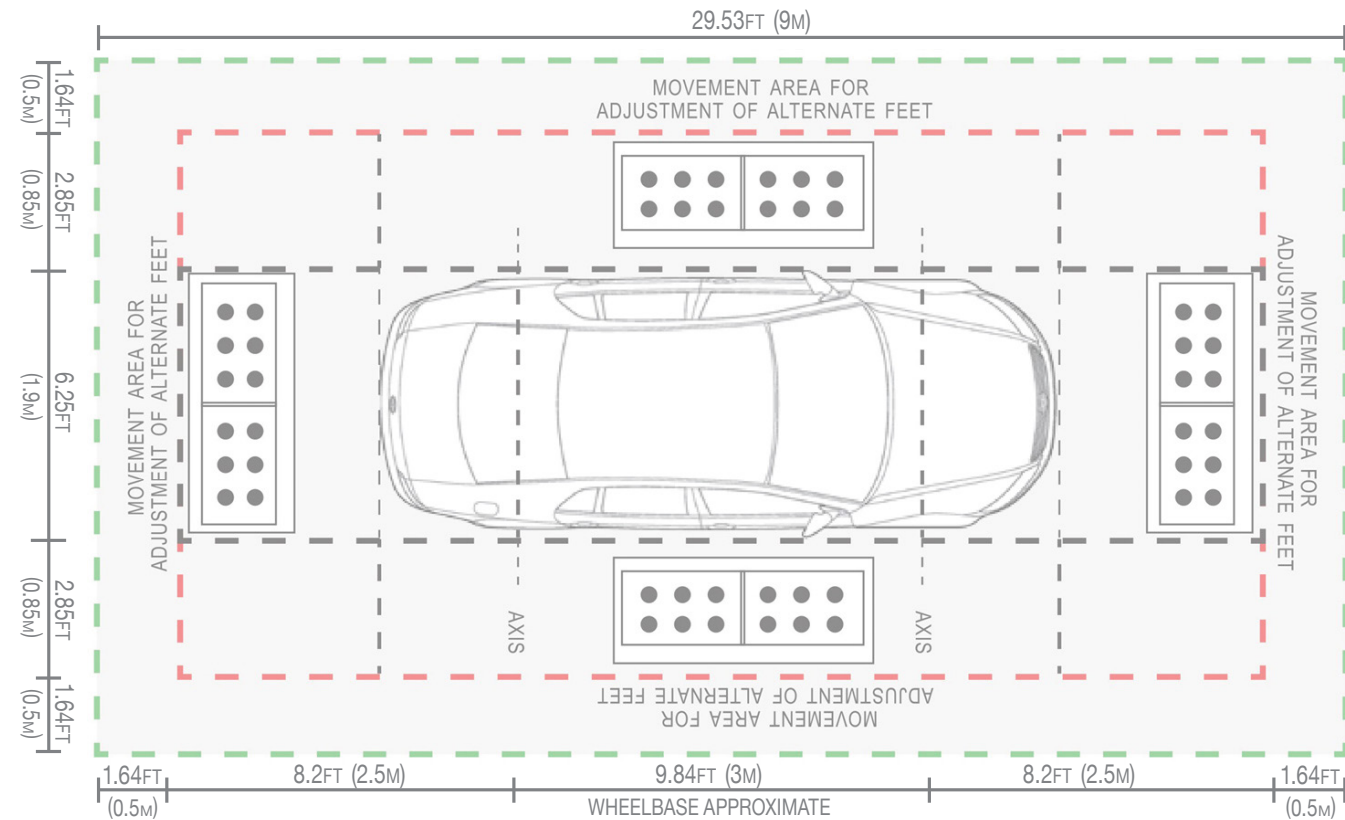



ADAS LEVEL AREA

CALIBRATION SURFACE REQUIREMENTS

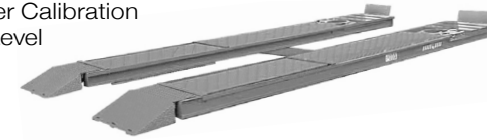
- Level Surface Required for Proper Calibration
- Alignment Lift Can Be Used To Level
- Diagnostic Software Instruction



-  CLEAR & LEVEL SURROUNDING
-  BAY SIZE AREA REQUIREMENT

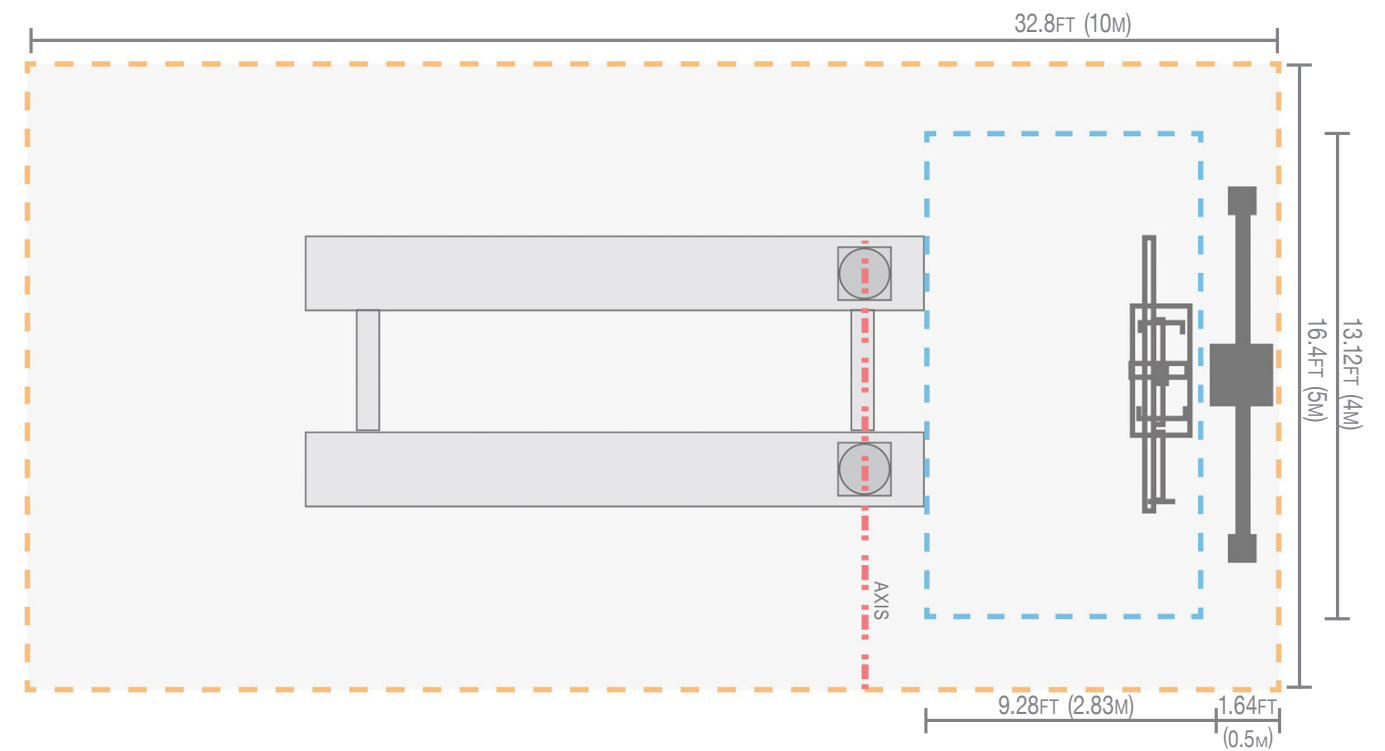

CAMERA & SENSOR CALIBRATION

- Stationary Target and Pattern Calibration is The OE Preferred Method for Camera Sensor Calibration
- Radar Sensors Require A Stationary Adjustment Followed By An On-Road Procedure to Complete

- Mobile Calibration Does Not Require A Target
- Dynamic Calibration Requires a Scan Tool To Initiate A Learning Process To Complete
- Test Drive With Straight and Clear Lane Markings To Allow The Adaptation To Complete
- Scan Tool Will Provide OE Specified Parameters

FIXED / STATIONARY



MOBILE / DYNAMIC



The Autel calibration frame provides compatible use with vehicle leveling lifts by offering a taller than average extended adjustable height. The large automatic screw mechanism quickly raises and lowers the calibration frame pattern board and crossbar to meet the vehicle.

FROM FLOOR TO MIDDLE OF PATTERN BOARD

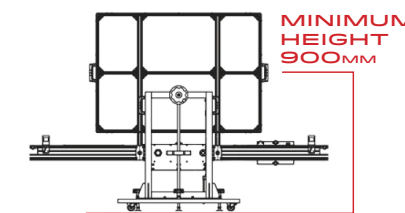

MINIMUM HEIGHT 900MM

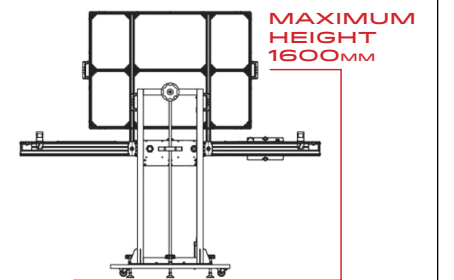

MAXIMUM HEIGHT 1600MM

Alignment procedure required to calibrate OE specified vehicle thrust angle before completing ADAS calibrations.

Autel ADAS calibration frame provides OE equivalent accuracy by wheel clamps attached securely to rim. Precise laser leveling from the Autel wheel clamp ensures the lowest degree of deviation from the OE specified thrust angle.

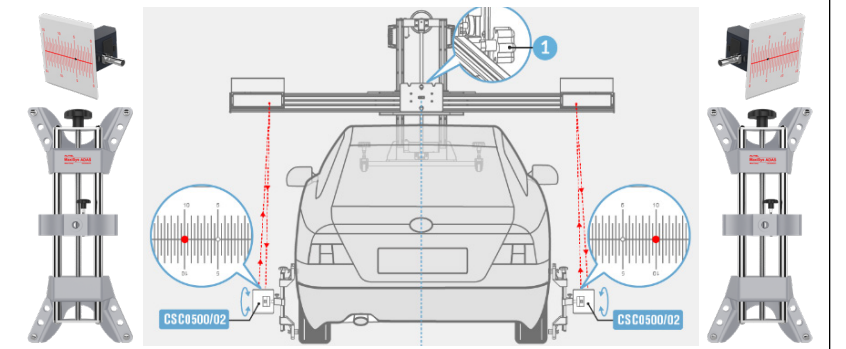









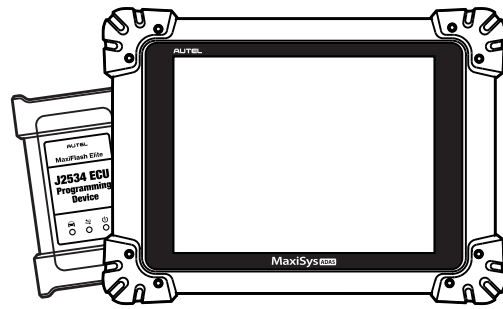



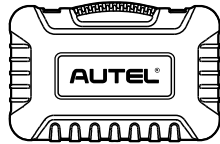



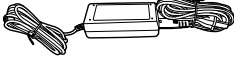

MaxiSYS ADAS Part#

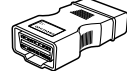
ADASTABLET

PACKING LIST

Calibration Tablet Diagnostic Package

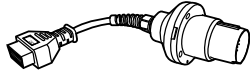

MS908ADAS Main Unit 	1pc	MaxiFLASH Elite J2534 	1pc	Carrying Case 	1pc
Main OBDII Cable 	1pc	USB Cable 	1pc	Mini USB Cable 	1pc
AC/DC Adapter (12v) 	1pc	ACC Charger & 2 Fuses 	1pc	Honda-3 Connector 	1pc
Nissan-14 Connector 	1pc	Mitsubishi / Hyundai 12+16 	1pc	GM/Daewoo-12 	1pc
Chrysler-16 Connector 	1pc	VW/Audi 2+2 Connector 	1pc	Benz-14 Connector * For Euro Use Only 	1pc
Kia-20 Connector 	1pc	BMW-20 Connector 	1pc	Benz-38 Connector 	1pc
User Reference Manual 	1pc	Quick Start Guide 	1pc	* This connector is not included with units sold in North America	

AUTEL UPDATES PROVIDE LATEST OE COVERAGE
1 YEAR FREE SOFTWARE
 REGISTER AND UPDATE TOOLS AFTER PURCHASE



AUTEL TRAINING COURSES AVAILABLE



YouTube
 TRAINING VIDEOS



@AutelTools



autel.com
 maxitpms.com



Follow Us @AutelTools
 f t i YouTube

AUTEL